

IND560x

Weighing Terminal



METTLER TOLEDO

IND560x Weighing Terminal

METTLER TOLEDO Service

Essential Services for Dependable Performance of Your IND560x Weighing Terminal

Congratulations on choosing the quality and precision of METTLER TOLEDO. Proper use of your new equipment according to this Manual and regular calibration and maintenance by our factory-trained service team ensures dependable and accurate operation, protecting your investment. Contact us about a service agreement tailored to your needs and budget. Further information is available at www.mt.com/service.

There are several important ways to ensure you maximize the performance of your investment:

1. **Register your product:** We invite you to register your product at www.mt.com/productregistration so we can contact you about enhancements, updates and important notifications concerning your product.
2. **Contact METTLER TOLEDO for service:** The value of a measurement is proportional to its accuracy – an out of specification scale can diminish quality, reduce profits and increase liability. Timely service from METTLER TOLEDO will ensure accuracy and optimize uptime and equipment life.
 - a. **Installation, Configuration, Integration and Training:** Our service representatives are factory-trained, weighing equipment experts. We make certain that your weighing equipment is ready for production in a cost effective and timely fashion and that personnel are trained for success.
 - b. **Initial Calibration Documentation:** The installation environment and application requirements are unique for every industrial scale so performance must be tested and certified. Our calibration services and certificates document accuracy to ensure production quality and provide a quality system record of performance.
 - c. **Periodic Calibration Maintenance:** A Calibration Service Agreement provides on-going confidence in your weighing process and documentation of compliance with requirements. We offer a variety of service plans that are scheduled to meet your needs and designed to fit your budget.
 - d. **GWP® Verification:** A risk-based approach for managing weighing equipment allows for control and improvement of the entire measuring process, which ensures reproducible product quality and minimizes process costs. GWP (Good Weighing Practice), the science-based standard for efficient life-cycle management of weighing equipment, gives clear answers about how to specify, calibrate and ensure accuracy of weighing equipment, independent of make or brand.

© METTLER TOLEDO 2022

No part of this manual may be reproduced or transmitted in any form or by any means, electronic or mechanical, including photocopying and recording, for any purpose without the express written permission of METTLER TOLEDO.

U.S. Government Restricted Rights: This documentation is furnished with Restricted Rights.

Copyright 2022 METTLER TOLEDO. This documentation contains proprietary information of METTLER TOLEDO. It may not be copied in whole or in part without the express written consent of METTLER TOLEDO.

COPYRIGHT

METTLER TOLEDO® is a registered trademark of Mettler-Toledo, LLC. All other brand or product names are trademarks or registered trademarks of their respective companies.

METTLER TOLEDO RESERVES THE RIGHT TO MAKE REFINEMENTS OR CHANGES WITHOUT NOTICE.

FCC Notice

This device complies with Part 15 of the FCC Rules and the Radio Interference Requirements of the Canadian Department of Communications. Operation is subject to the following conditions: (1) this device may not cause harmful interference, and (2) this device must accept any interference received, including interference that may cause undesired operation.

This equipment has been tested and found to comply with the limits for a Class A digital device, pursuant to Part 15 of FCC Rules. These limits are designed to provide reasonable protection against harmful interference when the equipment is operated in a commercial environment. This equipment generates, uses, and can radiate radio frequency energy and, if not installed and used in accordance with the instruction manual, may cause harmful interference to radio communications. Operation of this equipment in a residential area is likely to cause harmful interference in which case the user will be required to correct the interference at his or her expense.

- Declaration of Conformity may be found at <http://glo.mt.com/us/en/home/search/compliance.html/compliance/>.

NOTE ON FIRMWARE VERSIONS



















This manual describes features and functions of the IND560x terminal with version **4.xx** firmware. Terminals with other versions of firmware may differ in some areas.







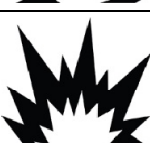











Statement regarding harmful substances

We do not make direct use of harmful materials such as asbestos, radioactive substances or arsenic compounds. However, we purchase components from third party suppliers, which may contain some of these substances in very small quantities.

Warnings and Cautions

- READ this manual BEFORE operating or servicing this equipment and FOLLOW these instructions carefully.
- SAVE this manual for future reference.

	<p style="text-align: center;"> WARNING</p> <p>DO NOT INSTALL OR PERFORM ANY SERVICE ON THIS EQUIPMENT BEFORE THE AREA IN WHICH THE IND560X IS LOCATED HAS BEEN SECURED AS NON-HAZARDOUS BY PERSONNEL AUTHORIZED TO DO SO BY THE RESPONSIBLE PERSON AT THE CUSTOMER'S SITE.</p>
	<p style="text-align: center;"> WARNING</p> <p>NOT ALL VERSIONS OF THE IND560 ARE DESIGNED FOR USE IN HAZARDOUS (EXPLOSIVE) AREAS. REFER TO THE DATA PLATE OF THE IND560 TO DETERMINE IF A SPECIFIC TERMINAL IS APPROVED FOR USE IN AN AREA CLASSIFIED AS HAZARDOUS BECAUSE OF COMBUSTIBLE OR EXPLOSIVE ATMOSPHERES.</p>
	<p style="text-align: center;"> WARNING</p> <p>USE THE WEIGHING TERMINAL ONLY WHEN ELECTROSTATIC PROCESSES LEADING TO PROPAGATION BRUSH DISCHARGE IS IMPOSSIBLE.</p>
	<p style="text-align: center;"> WARNING</p> <p>AVOID ELECTROSTATIC CHARGING DURING OPERATION AND MAINTENANCE.</p>
	<p style="text-align: center;"> WARNING</p> <p>OPERATION IS ONLY PERMITTED WHEN OPERATIONAL AND PROCESS-RELATED ELECTROSTATIC CHARGES ARE ELIMINATED.</p>
	<p style="text-align: center;"> WARNING</p> <p>KEEP THE TERMINAL AWAY FROM PROCESSES THAT GENERATE HIGH CHARGING POTENTIAL SUCH AS ELECTROSTATIC COATING, RAPID TRANSFER OF NON-CONDUCTIVE MATERIALS, RAPID AIR JETS, AND HIGH PRESSURE AEROSOLS.</p>
	<p style="text-align: center;"> WARNING</p> <p>DO NOT USE DRY CLOTH TO CLEAN THE WEIGHING TERMINAL. ALWAYS USE A DAMP CLOTH TO CLEAN THE TERMINAL GENTLY.</p>
	<p style="text-align: center;"> WARNING</p> <p>WEAR SUITABLE CLOTHING. AVOID NYLON, POLYESTER OR OTHER SYNTHETIC MATERIALS THAT GENERATE AND HOLD CHARGE. USE CONDUCTIVE FOOTWEAR AND FLOORING.</p>
	<p style="text-align: center;"> WARNING</p> <p>AVOID PLASTIC COVERS OVER THE TERMINAL.</p>

	<p style="text-align: center;"> WARNING</p> <p>ENSURE PROPER EQUIPOTENTIAL GROUNDING OF THE TERMINAL, MOUNTING ACCESSORIES, AND THE SCALE BASE.</p>
	<p style="text-align: center;"> WARNING</p> <p>IF THE IND560X KEYBOARD, DISPLAY LENS OR ENCLOSURE IS DAMAGED, THE DEFECTIVE COMPONENT MUST BE REPAIRED IMMEDIATELY. REMOVE POWER IMMEDIATELY AND DO NOT REAPPLY POWER UNTIL THE DISPLAY LENS, KEYBOARD OR ENCLOSURE HAS BEEN REPAIRED OR REPLACED BY QUALIFIED SERVICE PERSONNEL. FAILURE TO DO SO COULD RESULT IN BODILY HARM AND/OR PROPERTY DAMAGE.</p>
	<p style="text-align: center;"> WARNING</p> <p>ONLY THE COMPONENTS SPECIFIED IN THIS MANUAL CAN BE USED IN THIS DEVICE. ALL EQUIPMENT MUST BE INSTALLED IN ACCORDANCE WITH THE INSTALLATION INSTRUCTIONS DETAILED IN THIS MANUAL. INCORRECT OR SUBSTITUTE COMPONENTS AND/OR DEVIATION FROM THESE INSTRUCTIONS CAN IMPAIR THE INTRINSIC SAFETY OF THE TERMINAL AND COULD RESULT IN BODILY INJURY AND/OR PROPERTY DAMAGE.</p>
	<p style="text-align: center;"> WARNING</p> <p>TO PREVENT IGNITION OF HAZARDOUS ATMOSPHERES, DISCONNECT THE IND560X FROM ITS POWER SOURCE BEFORE OPENING THE ENCLOSURE. KEEP COVER TIGHTLY CLOSED WHILE THE CIRCUIT IS ENERGIZED. DO NOT OPEN WHEN AN EXPLOSIVE DUST ATMOSPHERE IS PRESENT.</p>
	<p style="text-align: center;"> WARNING</p> <p>FOR CONTINUED PROTECTION AGAINST SHOCK HAZARD, CONNECT TO PROPERLY GROUNDED POWER SOURCE ONLY. DO NOT REMOVE THE GROUNDING CONNECTION.</p>
	<p style="text-align: center;"> WARNING</p> <p>WHEN THIS EQUIPMENT IS INCLUDED AS A COMPONENT PART OF A SYSTEM, THE RESULTING DESIGN MUST BE REVIEWED BY QUALIFIED PERSONNEL WHO ARE FAMILIAR WITH THE CONSTRUCTION AND OPERATION OF ALL COMPONENTS IN THE SYSTEM AND THE POTENTIAL HAZARDS INVOLVED. FAILURE TO OBSERVE THIS PRECAUTION COULD RESULT IN BODILY HARM AND/OR PROPERTY DAMAGE.</p>
	<p style="text-align: center;"> WARNING</p> <p>ONLY PERMIT QUALIFIED PERSONNEL TO SERVICE THE IND560X. EXERCISE CARE WHEN MAKING CHECKS, TESTS AND ADJUSTMENTS THAT MUST BE MADE WITH POWER ON. FAILING TO OBSERVE THESE PRECAUTIONS CAN RESULT IN BODILY HARM AND/OR PROPERTY DAMAGE.</p>
	<p style="text-align: center;"> WARNING</p> <p>ALL EQUIPMENT MUST BE INSTALLED IN ACCORDANCE WITH THE INSTALLATION INSTRUCTIONS DETAILED IN THIS MANUAL. DEVIATION FROM THE INSTRUCTIONS CAN IMPAIR THE INTRINSIC SAFETY OF THE TERMINAL AND VOID THE AGENCY APPROVAL.</p>
	<p style="text-align: center;"> CAUTION</p> <p>BEFORE CONNECTING/DISCONNECTING ANY INTERNAL ELECTRONIC COMPONENTS OR INTERCONNECTING WIRING BETWEEN ELECTRONIC EQUIPMENT ALWAYS REMOVE POWER AND WAIT AT LEAST THIRTY (30) SECONDS BEFORE ANY CONNECTIONS OR DISCONNECTIONS ARE MADE. FAILURE TO OBSERVE THESE PRECAUTIONS COULD RESULT IN DAMAGE TO OR DESTRUCTION OF THE EQUIPMENT AND/OR BODILY HARM.</p>

NOTICE

BE CERTAIN THAT THE COMMUNICATION CIRCUITS ARE WIRED EXACTLY AS SHOWN IN THE INSTALLATION SECTION OF THIS MANUAL. IF THE WIRES ARE NOT CONNECTED CORRECTLY, THE IND560X TERMINAL OR INTERFACE BOARD MAY BE DAMAGED.



NOTICE

OBSERVE PRECAUTIONS FOR HANDLING ELECTROSTATIC SENSITIVE DEVICES.

Disposal of Electrical and Electronic Equipment

In conformance with the European Directive 2012/19/EC on Waste Electrical and Electronic Equipment (WEEE) this device may not be disposed of in domestic waste. This also applies to countries outside the EU, per their specific requirements.



Please dispose of this product in accordance with local regulations at the collecting point specified for electrical and electronic equipment.

If you have any questions, please contact the responsible authority or the distributor from which you purchased this device.

Should this device be passed on to other parties (for private or professional use), the content of this regulation must also be related.

Thank you for your contribution to environmental protection.

Contents

1	Introduction	1-1
1.1.	IND560x Overview	1-1
1.2.	IND560x Terminal Versions.....	1-2
1.3.	Standard IND560x Features	1-2
1.4.	Warnings and Precautions	1-4
1.5.	Equipotential Bonding (EB).....	1-4
1.6.	Operating Environment	1-5
1.7.	Inspection and Contents Checklist	1-5
1.8.	Physical Dimensions.....	1-6
1.9.	Specifications	1-9
1.10.	Manufacture Date.....	1-12
1.11.	Main PCB	1-12
1.12.	IND560x Options	1-14
1.13.	Safe Area Communication Options	1-18
1.14.	Additional Accessories	1-21
1.15.	Display and Keypad.....	1-22
2	Operation	2-1
2.1.	Overview.....	2-1
2.2.	Security	2-1
2.3.	Display Operation	2-3
2.4.	Understanding the Navigational Interface.....	2-6
2.5.	Home Screen.....	2-12
2.6.	Basic Functionality	2-13
2.7.	Alibi Memory Direct Access	2-36
2.8.	Table Searches	2-37
2.9.	Remote Display	2-37
2.10.	Automatic Reconnection to ACM500 Communication Module	2-37
3	Configuration	3-1
3.1.	Entering Setup Mode	3-1
3.2.	Exiting Setup Mode	3-2
3.3.	Setup Menu Tree	3-2
3.4.	Overview of Configuration	3-5
3.5.	Scale.....	3-7

3.6.	Application	3-29
3.7.	Terminal	3-42
3.8.	Communication	3-49
3.9.	Maintenance	3-77
3.10.	Restoring Factory Default Settings	3-85
4	Service and Maintenance	4-1
4.1.	Terminal Cleaning and Maintenance.....	4-1
4.2.	Service	4-2
4.3.	Display Messages.....	4-3
4.4.	Setting a Custom Language.....	4-4
4.5.	External Diagnostics.....	4-7

1 Introduction

1.1. IND560x Overview

The IND560x represents the latest in METTLER TOLEDO technology and is the most versatile weighing terminal available today. The IND560x is suitable for use in industrial weighing applications inside hazardous (classified) areas. The IND560x terminal has global agency approvals that permit operation within Division 1 or Zone 1/21 hazardous locations.

The IND560x terminal is a high-performance single- or multiple-range weighing terminal designed for use with analog load cells or high-precision IDNet and SICSpro scale interfaces. The IND560x delivers precision measurement data from milligrams to tons in a single cost effective package that easily integrates into existing systems.

Power options include an external power supply that converts high level AC voltage to intrinsically safe DC voltages and is still suitable for installation inside the hazardous area. An external battery for use in mobile applications is also available for use with the harsh/analog model of the IND560x.

PLC and PC communication interfaces are available through easy to install safe area communication modules. Internal and remote digital I/O options provide control for process applications such as filling. The versatile IND560x can be upgraded with a variety of special application software packages that add performance features where needed. These features make the IND560x the perfect match for nearly any weighing application in many industries, including:

- Pharmaceuticals
- Petrochemicals
- Refining
- Milling
- Agriculture
- Cosmetics and Fragrance
- Specialty Chemical
- Coatings and Inks

1.2. IND560x Terminal Versions



Figure 1-1: Harsh (left) and Panel Mount (right) Enclosures for the IND560x

The IND560x terminal is available in the following versions:

- Harsh enclosure with analog load cell connection
- Harsh enclosure with high-precision (IDNet or SICSpro) base connection
- Panel-mount enclosure with analog load cell connection
- Panel-mount enclosure with high-precision (IDNet or SICSpro) base connection

1.3. Standard IND560x Features

- Basic weighing in hazardous (explosive) areas including zero, tare and printing
- Panel-mount or harsh desk/wall-mount enclosures
- Connect one analog load cell scale base (or up to four 350 ohm load cells), or an IDNet or SICSpro base depending upon the version of the IND560x
- 128 × 64 dot-matrix graphic backlit liquid crystal display (LCD) with 21mm high weight display
- Real-time clock (battery backup)
- Includes one intrinsically safe serial port (COM1) for asynchronous, bidirectional communication and print output
- Operates with the intrinsically safe APS768x or PSUx power supply. An external NiMH battery pack is available for use with the harsh/analog model
- Supports the following internal option boards:
 - Discrete I/O Interfaces
 - Dual channel intrinsically safe current loop interface
 - or
 - Dual channel fiber optic interface

- Support for the following options utilizing the ACM500 communication module in the safe area:
 - Analog Output
 - EtherNet/IP™
 - Allen-Bradley® RIO (discontinued, January 2021)
 - Ethernet TCP/IP with two serial ports (Ethernet/COM2/COM3)
 - DeviceNet™ (Discontinued, December 2022)
 - PROFIBUS® DP
 - Modbus TCP
- ID mode for prompted transaction sequencing
- Selectable over/under classifying mode of operation
- Selectable material transfer mode for simple filling or dosing
- SmartTrac™ graphical display
- Comparators for simple comparison of weight or rate
- Two memory tables – store 25 Tare and 25 Target records
- Unit switching between three different units, including custom units
- Alibi memory storage for up to 60,000 records
- Grand total and subtotal registers for accumulating weight
- Five customizable print templates and report printing
- TraxDSP™ digital filtering for analog load cells
- TraxEMT™ performance monitoring and recording
- CalFREE™ calibration without test weights
- Support of the following Application Software Modules:
 - Fill-560
 - Drive-560
 - FillPlus
 - TaskExpert®
 - COM-560

For information regarding METTLER TOLEDO Technical Training contact:

METTLER TOLEDO US

1900 Polaris Parkway
 Columbus, Ohio 43240
 Phone (US and Canada): (614) 438-4511
 Phone (International): (614) 438-4888
www.mt.com





METTLER TOLEDO

Postfach 250
 D-72423 Albstadt, Germany
 Phone: (+49-7431) 140
www.mt.com

1.4. Warnings and Precautions

Please read these instructions carefully before putting the new terminal into operation.

Although the IND560x is ruggedly constructed, it is nevertheless a precision instrument. Use care in handling and installing the terminal.

	 WARNING
	DO NOT INSTALL OR PERFORM ANY SERVICE ON THIS EQUIPMENT BEFORE THE AREA HAS BEEN SECURED AS NON-HAZARDOUS BY PERSONNEL AUTHORIZED TO DO SO BY THE RESPONSIBLE PERSON AT THE CUSTOMER'S SITE.
	 WARNING
	ONLY THE COMPONENTS SPECIFIED IN THIS MANUAL CAN BE USED IN THIS TERMINAL. ALL EQUIPMENT MUST BE INSTALLED IN ACCORDANCE WITH THE INSTALLATION INSTRUCTIONS DETAILED IN THIS MANUAL. INCORRECT OR SUBSTITUTE COMPONENTS AND/OR DEVIATION FROM THESE INSTRUCTIONS CAN IMPAIR THE INTRINSIC SAFETY OF THE TERMINAL AND COULD RESULT IN BODILY INJURY AND/OR PROPERTY DAMAGE.

1.5. Equipotential Bonding (EB)

Equipotential bonding must be installed by an electrician authorized by the owner. METTLER TOLEDO Service performs only a monitoring and consulting function for this procedure.

Connect equipotential bonding of all devices (power supply unit, weighing terminal, interface converter and weighing platform) in accordance with the terminal diagram and all country-specific regulations and standards. In the process, it must be ensured that:

- All device housings are connected to the same potential via the EB terminals.
- No circulating current flows via the cable shielding for intrinsically safe circuits.
- The neutral point for equipotential bonding is as close to the weighing system as possible.

1.5.1. Warnings

1.5.1.1. CENELEC

1.5.1.1.1. Connection of EB per Country-Specific Regulations

It must be ensured that the housings of all devices are connected to the same potential via the EB terminals. No circulating current may flow via the shielding of the intrinsically safe cables.

1.5.1.2. cFMus

1.5.1.2.1. Connection of EB per ANSI/NFPA 70, Article 504, and ANSI/IA RP 12.06.01 or Canadian Electric Code C22.2

It must be ensured that the housings of all devices are connected to the same potential via the EB terminals. No circulating current may flow via the shielding of the intrinsically safe cables.

1.6. Operating Environment

When selecting a location:s

- Use the weighing terminal only when electrostatic processes leading to propagation brush discharge is impossible.
- Keep the terminal away from processes that generate high charging potential such as electrostatic coating, rapid transfer of non-conductive materials, rapid air jets, and high pressure aerosols.
- Choose a stable, vibration-free surface to mount the terminal
- Ensure there are no excessive fluctuations in temperature and no direct exposure to sunlight
- Avoid drafts on the weighing platform (for example, from open windows or air conditioning)
- Calibrate the terminal after any major change of geographical location

1.6.1. Temperature and Humidity

The IND560x can be stored and operated at temperatures and relative humidity conditions as listed in Table 1-1.

1.6.2. Environmental Protection

The IND560x harsh and panel-mount terminals have environmental protection as listed in Table 1-1.

1.6.3. Hazardous Areas

The intrinsically safe IND560x terminal is designed to operate within an area classified as Division 1, Zone 1 or Zone 21.

- **IMPORTANT:** Not all models in the IND560 terminal family can be operated in areas classified as Hazardous because of the combustible or explosive atmospheres in those areas. Before installation, check the data plate of the terminal to confirm it is marked with the approval for the environment in which it will be used.

1.7. Inspection and Contents Checklist

Verify the contents and inspect the package immediately upon delivery. If the shipping container is damaged, check for internal damage and file a freight claim with the carrier if necessary. If the container is not damaged, remove the IND560x terminal from its protective package, noting how it was packed, and inspect each component for damage.

If shipping the terminal is required, it is best to use the original shipping container. The IND560x terminal must be packed correctly to ensure its safe transportation.

The IND560x package should include:

- IND560x Terminal
- Bag of miscellaneous parts

- Printed Installation manual
- Documentation CD
- Gasket (panel-mount only)

1.8. Physical Dimensions

The dimensions for the panel-mount and harsh enclosures of the IND560x terminal are shown below.

1.8.1. Panel-mount Enclosure

The physical dimensions for the panel-mount enclosure of the IND560x terminal are shown in Figure 1-2 in inches and [mm].

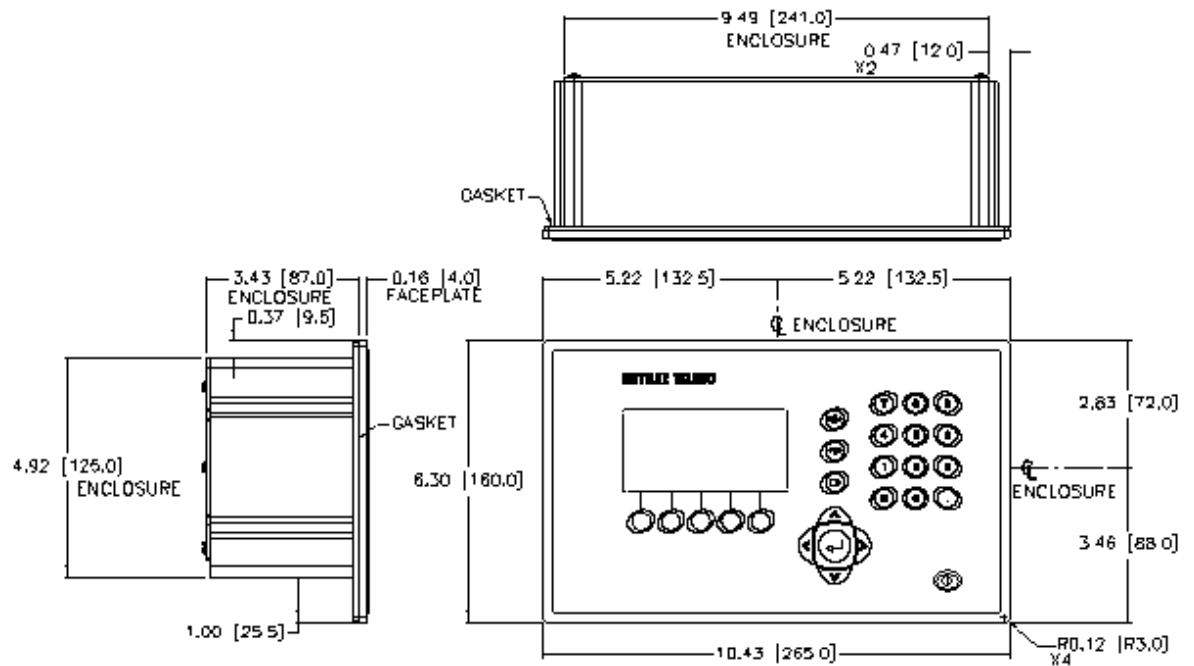

Figure 1-2: IND560x Panel-Mount Enclosure Dimensions

The physical dimensions for the panel cutout of the IND560x terminal are shown in Figure 1-3 in inches and [mm].

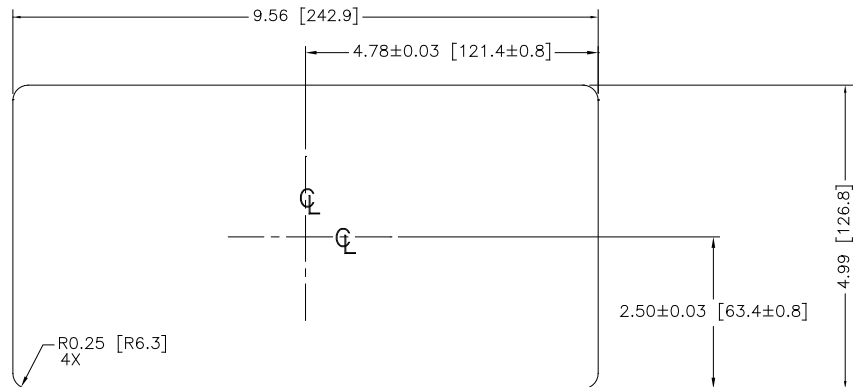

Figure 1-3: IND560x Panel-Mount Cutout Dimensions

1.8.2. Harsh Enclosure

The physical dimensions for the harsh desk and wall-mount enclosures of the IND560x terminal are shown in Figure 1-4 and Figure 1-5, in inches and [mm].

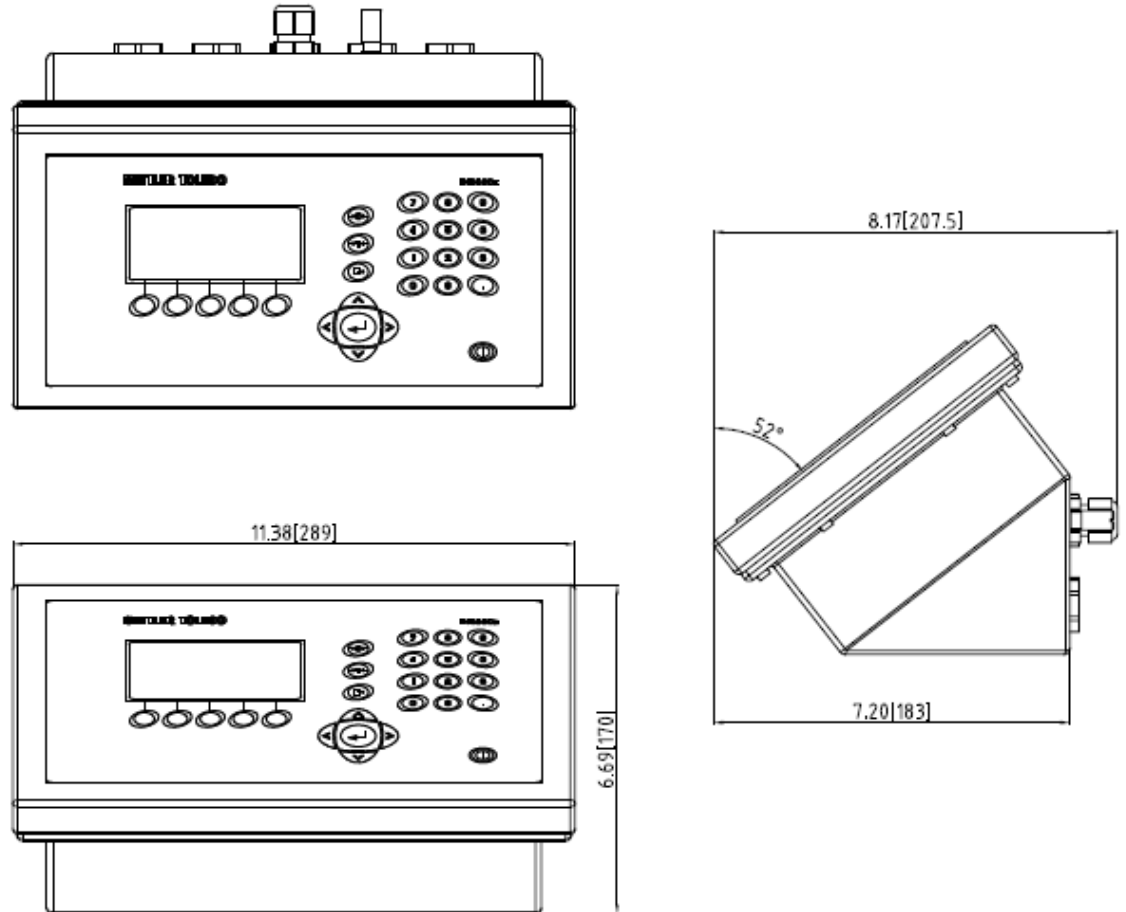

Figure 1-4: IND560x Harsh, Desk Mount Dimensions

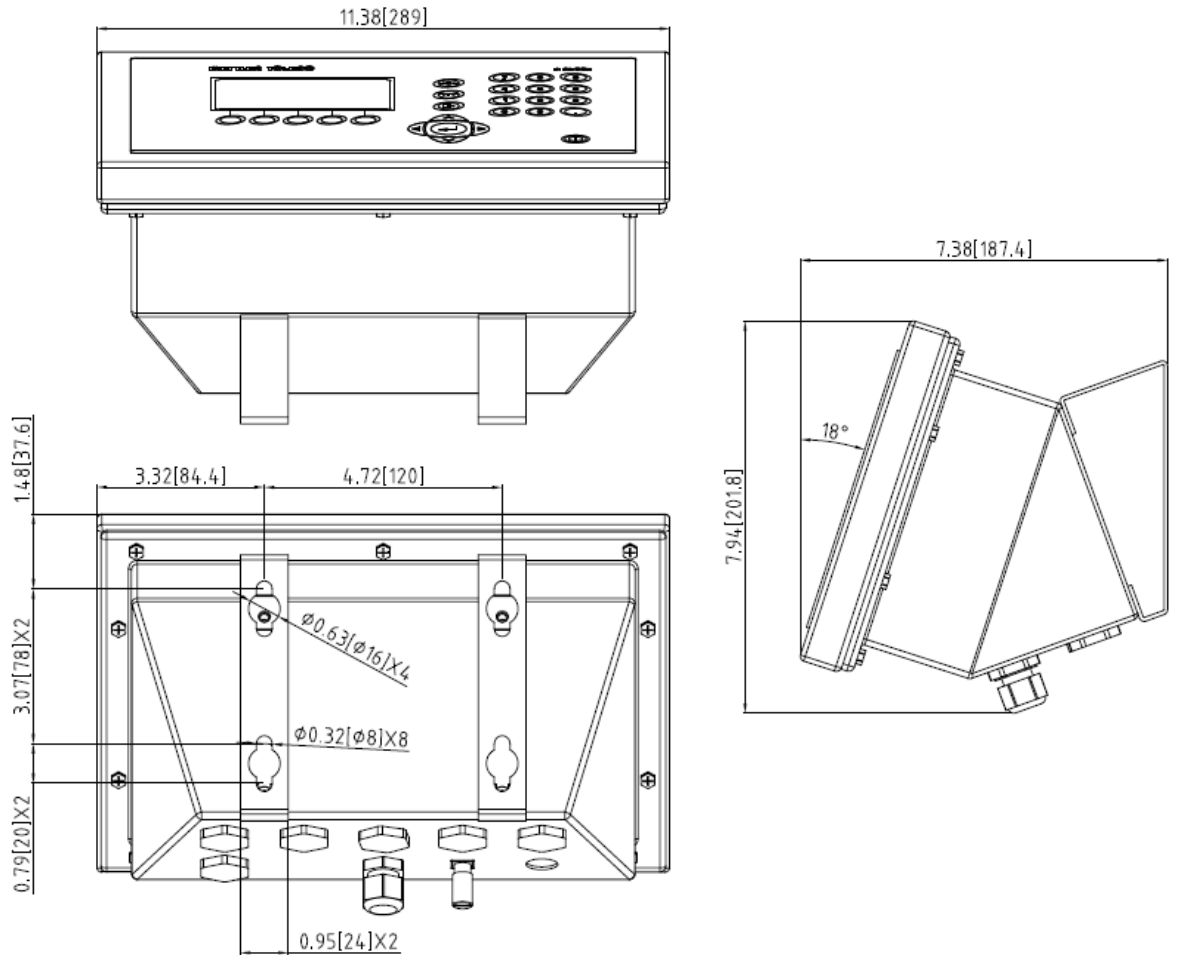

Figure 1-5: IND560x Harsh Wall Mount Dimensions - Shown With Optional Wall Mounting Bracket

1.9. Specifications

The IND560x terminal conforms to the specifications listed in Table 1-1.

Table 1-1: IND560x Specifications

IND560x Specifications	
Enclosure Type	Panel Mount: stainless steel front panel with an aluminum chassis
	Harsh Environment desk/wall/column-mount: type 304L stainless steel enclosure
Dimensions (h × w × d)	Panel Mount: 160 mm × 265 mm × 92 mm (6.3 in. × 10.4 in × 3.6 in.)
	Harsh Environment: 170 mm × 289 mm × 183 mm (6.7 in. × 11.4 in. × 7.2 in.)
Shipping Weight	3.5 kg (8 lb)

IND560x Specifications	
Environmental Protection	Panel Mount front panel sealing provides IP65 (comparable to TYPE 4 and TYPE 12 protection) - certified by DEKRA EXAM GmbH. Harsh Environment enclosure meets IP65 requirements certified by DEKRA EXAM GmbH, and IP68 and 69K certified by MTL.
Storage Environment	The terminal can be stored at temperatures ranging from -20°C to 60°C (-4° to 140°F) at 10 to 95% relative humidity, non-condensing.
Operating Environment	The terminal can be operated at temperatures ranging from -10° to 40°C (14° to 104°F) at 10% to 95% relative humidity non-condensing.
Hazardous Areas	The IND560x is approved for use in Division 1 and Zone 1/21 2 GD hazardous areas. Note that not all models in the IND560 terminal family can be operated in areas classified as Hazardous because of the combustible or explosive atmospheres in those areas. Before installation, check the data plate of the terminal to confirm it is marked with the approval for the environment in which it will be used.
Power	All models of the IND560x can operate with the PSUX or APS768x intrinsically safe power supplies. The PSUX and APS768x both provide several intrinsically safe voltages to the IND560x for its correct operation. The PSUX and APS768x are available in either a 120 VAC or a 230 VAC version. The IND560x harsh/analog model with the IND560x-PAB option installed operates with the METTLER TOLEDO intrinsically safe, external NiMH battery pack (P/Ns 64060627 & 64060625).
Display	128 × 64 dot-matrix graphic LCD display with LED backlight. 21 mm weight digits. Display Update Rate: 10/second
Weight Display	Displayed resolution of 100,000 counts for analog load cell scales. Display resolution for high-precision IDNet and SICSpro bases is determined by the specific base used.
Scale Types	Analog load cells or High-Precision IDNet, Kx Line (T-Brick Ex T4 type) or High-Precision SICSpro, PBK9/PFK9 Category 2 bases (MPXI load cells) or Point Ex module. SICSpro High-precision platforms that include Advanced Setup Mode. Update rate approximately 50 Hz. NOT COMPATIBLE WITH THE OLDER, PIK EX MODULE.
Number of Analog Cells	Four 350-ohm load cells (87 ohm minimum resistance), 2 or 3 mv/V
Number of Scales	Interface for one analog or one IDNet scale or one SICSpro scale
Analog/Digital Update Rates	Internal: Analog: >366 Hz; IDNet: determined by base; SICSpro: 50 Hz for bases that include Advanced Setup Mode Target Comparison: up to 50 Hz; PLC Interface: up to 20 Hz

IND560x Specifications	
Interface and Function Update Rates	Weight display: 10 Hz Internal discrete I/O: 25 Hz External discrete I/O (ARM100): 25 Hz PLC cyclic data: 25 Hz SICS continuous (SIR): 20 Hz MT Continuous Output: 20 Hz Continuous Template (serial): 18 Hz (115.2Kbaud), 14 Hz (38400 baud) Continuous Template (Eprint): 20 Hz
Clock Accuracy	Nominal 2 seconds/day at 25°C consistent room temperature. Nominal 8 seconds/day maximum for the temperature range -10°C to 40°C (14°F to 104°F)
Load Cell Excitation Voltage	5 VDC
Minimum Sensitivity	0.3 μ V/e approved
Keypad	26 keys; 1.5-mm thick polyester overlay (PET) with hardcoating. Polycarbonate display lens (PC).
Communications	<p>Standard Interfaces:</p> <p>One intrinsically safe RS-232 serial port (COM1), 300 to 115,200 baud</p> <p>Optional Interfaces:</p> <p>Ethernet/2 Serial Ports: Ethernet 10 Base-T and two additional serial ports (COM2 and COM3) available with ACM500 in safe area.</p> <p>Optional fiber optic interface communicates to ACM500 or legacy dual channel fiber optic converter.</p> <p>-- or --</p> <p>Optional dual-channel intrinsically safe current loop interface to ACM500 for PLC interface and/or Ethernet/COM2/COM3.</p> <p>-- or --</p> <p>Optional dual-channel intrinsically safe current loop interface to one or two ACM200 modules for RS-232 serial port (COM4, COM5)</p> <p>-- or --</p> <p>IND560x with intrinsically safe interface directly to IND226x with Interface-Remote installed for hazardous area remote display.</p> <p>Protocols</p> <p>Serial Inputs: Keypad input, ASCII commands for CTPZ (Clear, Tare, Print, Zero), SICS (most level 0 and level 1 commands)</p> <p>Serial Outputs: Continuous or Demand with up to five configurable print templates or SICS host protocol, report printing, interfaces with external ACM500 in safe area for Ethernet, COM2, COM3 and PLC interface.</p>
PLC Interfaces	Optional Allen-Bradley RIO (discontinued, January 2021), PROFIBUS DP, DeviceNet (Discontinued, December 2022), EtherNet/IP, Modbus TCP or Analog output are available using an expansion slot in the ACM500 (Accessory Communication Module) in the safe area.

IND560x Specifications	
Approvals	<p>Weights and Measures USA: Class II, 100,000d; Class III/IIIL, 10,000d; CoC #05-057A2 Canada: Class II, 100,000d; Class III, 10,000d; Class IIIHD, 20,000d; AM-5593 Rev 1 Europe: Class II, resolution determined by platform approval; Class III 10,000e; TC6812 Rev 5</p> <p>Hazardous Area U.S.: Certificate FM16US0438X and supplements IS, Class I, II, III; Div 1; Groups A-G T4 Ta=-10°C to +40°C, IP65, Type 4 I/1/AEx ib IIC T4 ATEX: Certificate BVS 09 ATEX E 010X and supplements II 2 G Ex ib [op is Ga] IIC T4 Gb II 2 D Ex ib [op is Da] IIIC T60°C Db IP65 Canada: Certificate FM16CA0199X and supplements Class I, II, III; Div 1; Groups A-G T4 Ta=-10°C to +40°C, IP65 IECEx: Certificate IECEx BVS 10.0096X and issue numbers Ex ib [op is Ga] IIC T4 Gb Ex ib [op is Da] IIIC T60°C Db IP65</p>

1.10. Manufacture Date

The product manufacturing date or the date code for the terminal can be found on the serial data plate (on the top of the enclosure).

1.11. Main PCB

The IND560x terminal's main printed circuit board (PCB) provides the scale interface for analog load cell, IDNet or SICSpro. The terminal must be ordered with the required scale interface - it cannot be modified later.

- Note: Connections for both the Analog load cells and an IDNet/SICSpro base are present on the main board of the IND560x simultaneously. However, only one connection has been enabled in the firmware of the board.

The main board also contains the DC power input connections, keyboard interface, bus connector for the display, bus connector for the discrete I/O option board and a connector for the intrinsically safe current loop or the fiber optic interface board (COM4 and COM5) connections.

An additional option board known as the IND560x-PAB (Power Adapter Board) must be installed onto the main board of the IND560x to make the terminal compatible with the external NiMH battery

pack. The IND560x-PAB can only be used with revision D or higher of the analog version of the main board. Refer to the Installation Manual for more information regarding the IND560x-PAB.

- Note: The revision level is not indicated on the IND560x main board. Revision D (and higher) main boards can be identified by the presence of the W3 jumper. If a main board has a W3 main jumper, it is at least revision D or higher. If the W3 jumper is not present, the main board is lower than revision D and cannot be used with the IND560x-PAB.

1.11.1. Analog Load Cell Scale Base

The IND560x can provide power for up to an 87 ohm load (four 350-ohm analog load cells). A jumper permits configuration for 2mV or 3mV load cells; the 3mV position is selected at the factory. A removable terminal strip is provided for the load cell connection.

- Note: When installed, the IND560x-PAB will cover the mV jumper. Please take this into consideration during installation of the IND560x analog model.

1.11.2. IDNet™ Scale Base

The IND560x supports the newer T-Brick Ex T4 style of intrinsically safe high-precision base through the main board IDNet port. This port provides the power and communication required to operate this newer style base.

- Note: The older PIK Ex module is not supported by the IND560x.
- Note: IND560x IDNet terminals cannot be used with the IND560x-PAB and external NiMH battery pack.

1.11.3. SICSpro Scale Base

The IND560x supports a SICSpro platform through the main board's SICSpro port. The SICSpro interface supports PBK9 and PFK9 high-precision platforms with MPXI load cells. The IND560x SICSpro interface supports only those SICSpro platforms that include the Advanced Setup Mode (ASM).

1.11.4. COM1 Serial Port

The main board also contains the COM1 serial port that provides intrinsically safe RS-232 communication. The port is bidirectional and can be configured and used for various functions such as demand output, SICS host communications, continuous output, ASCII command input (C, T, P, Z), ASCII character input, report printing, Shared Data Server access, or connection with the InSite PC Tool.

- Note: The approval entity parameters for the COM1 serial port must be checked for compatibility with those of the remote device when making direct connections to this port inside the hazardous area. When connecting COM1 to a peripheral in the safe area, a barrier will be required to properly protect the port and ensure safety of the system. Compare entity values of the IND560x terminal and the barrier to confirm safe compatibility before connecting.

1.12. IND560x Options

Some of the options and accessories available for use with the IND560x are described in the following sections. Note that some options require the use of the ACM500 communication module in the safe area.

1.12.1. Hardware Options

The following internal hardware options are available for the IND560x terminal:

- Fiber optic interface to connect to the ACM500 accessory communication module
- Intrinsically safe current loop interface to connect to the ACM500 module or ACM200 module
- Intrinsically safe discrete I/O with 4 inputs and 6 outputs
- IND560x-PAB (Power Adapter Board) to make the IND560x terminal compatible with the external NiMH battery pack

1.12.1.1. Dual Channel Fiber Optic Interface

A dual channel fiber optic interface can be used to connect an IND560x terminal to the ACM500 located in the safe area. This interface also provides connectivity to the older, dual-channel fiber optic converter (from an 8141, 8525, Puma, or ID3sTx installation).

- The fiber optic interface provides one or two channels of communication designed to use a hard clad silica fiber optic cable. High speed transmitters and receivers are used to increase the throughput of data. When combined with the ACM500 communication module and its options, this permits remote (safe area) operation of COM2 and COM3 serial ports, Ethernet and PLC interfaces at distances up to 300 meters (1000 ft.) from the IND560x terminal.
 - When used with the standard dual-channel fiber optic converter, this interface provides one or two additional bi-directional serial ports (COM4 and COM5) at the same distance.
 - The fiber optic interface can be used to communicate directly between two IND560x terminals in a Master-Remote configuration
- NOTE: Plastic core fiber optic cable can be used on short cable runs of 40 m (130 ft) or less.

1.12.1.2. Dual Channel IS Current Loop Interface

Instead of the fiber optic cable interface, an intrinsically safe, dual channel current loop (CL) interface can be used to connect an IND560x terminal to the ACM500 located in the safe area. This interface can also provide connectivity to the ACM200 converter in the safe area. Alternatively, the IND560x can be directly connected to an IND226x terminal acting as a remote display inside the hazardous area. In this scenario, the IND226x must be equipped with the Interface-Remote option.

- The current loop interface provides one or two channels of communication designed to use a copper wire cable. High speed transmitters and receivers are used to increase the throughput of data. When combined with the ACM500 communication module and its options, this permits remote (safe area) operation of COM2 and COM3 serial ports, Ethernet and PLC interfaces at distances up to 300 meters (1000 ft.) from the IND560x terminal.

- When used with the ACM200 safe area communication module, this interface provides an additional serial port (COM4 or COM5) at the same 300 meters (1000 ft.) distance from the IND560x terminal.
- This interface can also be used to operate an IND560x or IND226x terminal as a remote display to the IND560x. The remote terminal can be located up to 300 meters (1000 ft.) distance from the IND560x terminal.

1.12.1.3.

Discrete I/O

	 WARNING
	IN APPLICATIONS WHERE THE PLC CONTROLS THE DISCRETE OUTPUTS REMOTELY, LOSS OF PLC COMMUNICATION WILL NOT RETURN CONTROL OF DISCRETE OUTPUT/S TO THE TERMINAL.

Discrete I/O interface options include both internal and remote I/O. A maximum of 12 inputs and 18 outputs can be supported through a total of three options (internal and external, combined).

- The internal discrete I/O option is available in three different combinations of active/passive inputs and active/passive outputs. Both the inputs and outputs use solid state devices.
 - Active inputs and active outputs: The inputs are powered internally by the IND560x terminal and are designed for use with simple switches within the hazardous area. The inputs are not approved for direct connection to devices in the safe area - a remote ARM100 should be used for this. The outputs are also powered internally by the IND560x terminal and provide 12V switching at 50mA total. These outputs are intended for use with extremely low power intrinsically safe piezo electric solenoids.
 - Note: The Active/Active I/O option is not available for use with the IND560x-PAB and external NiMH battery pack.
 - Active inputs and passive outputs: The inputs are powered internally by the IND560x terminal and are designed for use with simple switches within the hazardous area. The inputs are not approved for direct connection to devices in the safe area - a remote ARM100 should be used for this. Power to operate the outputs must be provided by an external power supply and intrinsically safe barrier. Refer to the approval entity values for restrictions and limitations.
 - Passive inputs and passive outputs: Power to operate both the inputs and outputs must be provided by an external power supply and intrinsically safe barrier.
- Safe area remote I/O can be configured to communicate to an ARM100 device (refer to page 1-20) using the ACM200 with the CL/RS-422/RS-485 option or the ACM500 configured with Ethernet/COM2/COM3 option (refer to page 1-18 for additional details on the ACM500 and page 1-20 for ACM200). One other possibility is to use COM1 on the IND560x main board. This signal can be passed through an intrinsically safe barrier (ISB) and then through an RS-232 to RS-485 converter, both located in the safe area. The ARM100 provides six dry-contact outputs and four passive low voltage DC inputs. An external 12 - 24 volt DC supply is required to operate the ARM100.
 - NOTE: The ARM100 is NOT approved for use inside hazardous classified areas. An ARM100 must be installed in the safe area only.

1.12.1.4. IND560x-PAB

- NOTE: Due to space limitations and battery life limitations, the IND560x-PAB (Power Adapter Board) can only be used with the Harsh/Analog version of the IND560x. The IND560x-PAB will not work with any panel mount or IDNet or SICSpro models of the IND560x. The IND560x-PAB and external NiMH battery pack will also not support the Active-Active I/O option.

The IND560x-PAB option serves as a voltage splitter for the IND560x's external NiMH battery. The IND560x-PAB takes in the single voltage source from the external NiMH battery and splits it into the various voltages that are required for specific functions in the IND560x. The IND560x with PAB can only be used with the external, 8Ah NiMH battery pack, part #(s) 64060625 and 64060627.

1.12.2. Software Applications

The following add-on software applications are available for the IND560x terminal.

- Fill-560 (filling and dosing application)
- Fill-Plus (standard Fill-560 with a simple formula management add-on application)
- Drive-560 (simple vehicle management application)
- COM-560 (legacy host protocol application)
- TaskExpert (custom programming capability)

1.12.2.1. Fill-560

The Fill-560 is a special application that can be added to the IND560x terminal to provide material filling and dosing control for up to four materials. It provides control for the following combinations of weigh-in and weigh-out sequences.

- Fill only
- Fill and dump
- Dose out only
- Fill and dose out
- Blend only
- Blend and dump
- Blend and dose out

Additional information can be found in the Fill-560 Technical Manual on the documentation CD included with the Fill-560 option.

- Only one formula can be structured at a time. Once a change is made to any formula, its previous configuration is lost.

1.12.2.2. FillPlus

FillPlus is an add-on program created for the Fill-560 application. Like Fill-560, FillPlus is a special application that can be added to the IND560x terminal to provide filling and dosing control for up to 4 materials.

FillPlus provides a formula management and storage program that adds the following features to the Fill-560 application software:

- Storage of up to 25 multiple material formulas
- Scaling of formulas

- A single auxiliary output assignable for each formula

The FillPlus application is written with TaskExpert™. The tasks associated with FillPlus run independently of the Fill-560 base code.

Additional information is available in the Fill-560 & FillPlus Technical Manual, part # 64057366, found on the documentation CD that accompanies the Fill-560 and FillPlus application software kits, or a terminal that has been configured at the factory with the Fill-560 or FillPlus software.

1.12.2.3. Drive-560

The Drive-560 option is a specialized application solution focused on simple inbound-outbound vehicle weighing requirements. An IND560drive has two modes of operation: Temporary Tare ID Weighing and Permanent Tare ID Weighing. Some features of this software include:

- Storage of up to 100 Permanent Tare IDs
- Totalization of Permanent Tare IDs
- One-Step processing of Temporary IDs
- Reprint of previous transaction ticket
- Storage of up to 2000 transactions
- Inbound weight/date/time available on both Inbound and Outbound tickets

Additional information can be found in the Drive-560 Manual, part # 64062160, found on the documentation CD that accompanies the Drive-560 application.

1.12.2.4. COM-560

The COM-560 option is a specialized software module solution focused on the needs of users utilizing legacy communication protocols or that have special command requirements. The IND560com maintains all of the standard features and functions of the IND560 in addition to the specific features and functions of the COM-560. It provides the following features and functions:

- Custom ASCII command template
- Mettler Toledo Continuous Short output
- 8142 Host Protocol
- 8530 Host Protocol
- PT6S3 Protocol
- SMA Protocol

Additional information can be found in the COM-560 Technical Manual on the documentation CD included with the module.

1.12.2.5. TaskExpert™

TaskExpert functionality provides a way to modify the standard capabilities of the terminal so it can more closely align with specific application requirements. TaskExpert is a combination of a programming visualization tool, an execution engine and the basic functionality of the terminal. Modifications may be made to the sequence of operation and additional functionality added to the basic operation of the terminal.

1.13. Safe Area Communication Options

1.13.1. ACM500 Communication Module and Accessories



Figure 1-6: ACM500 Module

When Ethernet access, additional serial ports, or a PLC interface is required, an ACM500 communication module must be connected to the IND560x. The ACM500, which must be located in a non-hazardous area, receives data from the IND560x through the fiber optic interface or the intrinsically safe current loop interface. The ACM500 provides expansion slots for an Ethernet/COM2/COM3 option board and a single PLC option. Refer to the ACM500 Technical Manual or Installation Manual for details.

The following options for the IND560x require the use of the ACM500 communication module in the safe area:

- Ethernet/COM2/COM3
- Programmable Logic Control (PLC) interfaces
- Remote discrete I/O (in safe area) via ARM100 modules

1.13.2. Ethernet/COM2/COM3

The Ethernet port can be used for FTP transfer of tare and target tables and complete setup files. It also provides a TCP/IP port to transmit demand templates, continuous data, for access to data via the shared data server and to send email alerts when calibration expires or fails. This port can also be used for backing up and restoring the terminal configuration, using the METTLER TOLEDO InSite™ SL program.

COM2 provides RS-232 communication at rates from 300 to 115.2k baud. COM3 supports the same baud rates and provides an RS-232, RS-422, or RS-485 connection. COM3 can be used to update the firmware of the IND560x using the InSite™ CSL program.

When using COM2 or COM3 serial ports in the ACM500, it is recommended to use a network transmission baud rate of at least 9,600 Baud. Using COM2 or COM3 serial ports with network

transmission baud rates of 4,800 Baud or less may result in continuous data lagging behind real time conditions, or a delayed response to on-demand data requests (e.g., SICS requests).

1.13.3. PLC Interfaces

The IND560x terminal requires the use of the ACM500 module in the safe area to provide a PLC interface. Interfaces supported include Analog Output, A-B RIO (discontinued, January 2021), DeviceNet (Discontinued, December 2022), EtherNet/IP, Modbus TCP and PROFIBUS DP.

Additional details on these interfaces can be found in the IND560 PLC Interface Manual on the IND560x Documentation CD.

1.13.3.1. Analog Output

Analog Output refers to the representation of an internal system variable using a proportional electrical signal. Analog Output can be used to transmit a measured value, such as the gross or net weight or a rate. Another use for the Analog Output is as a control signal for some external device, such as a control valve, where the amount of valve opening is proportional to the analog signal commanding its operation. Such outputs are usually used to control the flow rate of material into or out of a vessel.

Both 0-10 volt DC and 4-20 mA signals are provided. Only one signal can be used at a time.

1.13.3.2. Allen-Bradley (A-B) RIO

■ The Allen Bradley RIO interface was discontinued in January 2021. The AB-RIO information in this manual is provided to support legacy installations only.

The A-B RIO option enables data exchange by bi-directional communications using the Discrete Data Transfer or Block Transfer mode. The terminal provides a communication exchange with the PLC approximately 20 times per second utilizing the Allen-Bradley Discrete Data Transfer protocol. This communication is a high-speed, real-time message interface between the terminal and the PLC for process control. Division, integer, and floating point values are supported.

The A-B RIO interface also supports Block Transfer mode for transmission of larger amounts of data.

1.13.3.3. DeviceNet

■ The DeviceNet interface was discontinued in December 2022. The DeviceNet information in this manual is provided to support legacy installations only.

DeviceNet is an RS-485 based network utilizing CAN chip technology. The network can be configured to run up to 500Kbits per second depending on cabling and distances. Messages are limited to 8 un-fragmented bytes. The network is capable of supporting up to 64 nodes including the master, commonly called the scanner.

1.13.3.4. EtherNet/IP

EtherNet/IP, short for "EtherNet Industrial Protocol," is an open industrial networking standard that takes advantage of commercial, off-the-shelf EtherNet communication chips and physical media. This networking standard supports both implicit messaging (real-time I/O messaging) and explicit

messaging (message exchange). The protocol is supported by ControlNet International (CI), the Industrial Ethernet Association (IEA) and the Open DeviceNet Vendor Association (ODVA).

1.13.3.5. Modbus TCP

Modbus/TCP is used to establish master-slave/client-server communication between intelligent devices. It is an open standard network protocol, widely used in the industrial manufacturing environment. The ModbusTCP protocol takes the Modbus instruction set and wraps TCP/IP around it.

1.13.3.6. PROFIBUS DP

The IND560x Terminal communicates to a PROFIBUS-DP master according to DIN 19 245. The PROFIBUS option consists of software that resides in the IND560x Terminal and a printed circuit board that installs in the ACM500 communication module to implement the data exchange.

1.13.4. **ARM100 Module**



Figure 1-7: ARM100 Module

The ARM100 Remote Discrete I/O Module is designed to extend the control network of METTLER TOLEDO industrial terminals. This high performance module provides four inputs and six dry-contact relay outputs at a remote location from a compatible terminal or communication module. Digital control information is communicated between the ARM100 and the terminal via an RS-485 communication link.

An external 10 – 32 VDC power supply is required to operate the ARM100 module. The ARM100 is only approved for installation in areas classified at SAFE.

1.13.5. **ACM200 Safe Area Communication Module**



Figure 1-8: ACM200 Safe Area Communication Module

The ACM200 converter can be used to convert the intrinsically safe current loop information from COM4 or COM5 of the IND560x terminal to an RS-232 signal inside the safe area. The ACM200 converter can be used to obtain demand or continuous RS-232 data from the IND560x or can

convert RS-232 signals in the safe area to intrinsically safe ASCII data and send to the IND560x. For a CL20mA or RS-422 or RS-485 signal inside the safe area, the ACM200 configured with the CL/RS-422/RS-485 option can be used. If the ACM500 is already connected to the IND560x terminal, it is not possible to connect the ACM200 converter. This is because both devices require dedicated use of the COM4 and COM5 ports of the IND560x terminal. The ACM200 is designed to communicate to the IND560x terminal using a copper wire communication cable at distances up to 300 m (1000 ft).

1.14. Additional Accessories

Additional accessories include:

- InSite™ SL PC Configuration Tool
- Legacy, dual channel fiber optic converter (safe area) for RS-232 or 20mA CL
- Glass core or plastic fiber optic cable
- Various brackets for wall and column mounting of the harsh enclosure

1.14.1. InSite™ SL Configuration Tool

InSite™ SL is available to end users of IND560x terminals. The IND560x terminal can connect to a PC running InSite™ SL via Ethernet or Serial to provide the following:

- Saving configuration information locally on the PC
- Loading a saved configuration file into other devices
- Restoring to a known state for service purposes.

1.14.2. InSite™ CSL Configuration Tool

 InSite™ CSL is available to certified Mettler Toledo service representatives.

The IND560x terminal can connect to a PC running InSite™ CSL to provide the following:

- Viewing and/or changing configuration.
- Enabling device-free configuration work before hardware installation.
- Saving configuration information locally on the PC, loading a saved configuration file into other devices, or restoring to a known state for service purposes.
- WYSIWYG print template editing tool with expanded viewing area, cut/paste functions, stored clipboard library (MyData items), and template space usage display.
- Printing documentation of configuration for users' records.
- Performing firmware upgrade services for the IND560x.

1.14.3. Legacy Fiber Optic Converters

The 0964-0043, -0058, -0059 and -0060 dual channel fiber optic converters can be used with the IND560x terminal to provide one or two additional channels of bidirectional communication at

distances up to 300m (1000 ft). The converters provide either RS-232 or 20mA current loop connectivity in the safe area, derived from the COM4 and COM5 ports of the terminal.

If the ACM500 is already connected to the IND560x terminal, it is not possible to connect the dual channel fiber optic converter. This is because both devices require dedicated use of the COM4 and COM5 ports of the IND560x terminal.

The IND560x and dual channel fiber optic converters are designed to use a hard clad silica fiber optic cable, but plastic core fiber optic cable can be used on short cable runs of 40 m (130 ft) or less.

1.15. Display and Keypad

The IND560x terminal has a Liquid Crystal Display (LCD), 128 × 64 dot matrix graphic type with a white LED backlight. Figure 1-9 shows the IND560x's display and keyboard layout.



Figure 1-9: The IND560x Display and Keyboard Layout

The display provides a system line at the top of the display for system messages and data; application area with weight display, legends, data entry, and other information in the middle; and soffkey labels (icons) across the bottom.

The system line shows system messages and any asynchronous errors. The middle portion of the display is reserved for the weight display and/or SmartTrac display. Random data entry (e.g. tare or target ID) is shown in the bottom of this area. The bottom of the display is reserved for showing the graphic labels (icons) for the soffkeys. Display positions for up to five soffkey icons are provided.

To the right of the soffkey icon area is a reserved space for a MORE UP (▲) or a MORE DOWN (▼) indicator. If present, these indicate additional soffkey selections are available by pressing either the UP or DOWN navigation keys. A total of 15 soffkeys may be programmed, depending upon the weighing options and terminal functions enabled. These are presented in three sets of five soffkeys. The soffkey setup and key mapping capabilities of the terminal determine the positioning of the soffkeys and locations where they display.

Three dedicated scale function keys are located to the right of the display. These are used to zero or tare the scale and to initiate a print.

The terminal's 12-key numeric keypad is used to enter data and commands. The numeric keys include a Clear key and a decimal point, and are located on the upper-right side of the terminal front panel.

Five navigation keys are located below the three scale function keys. These keys enable the operator to navigate through setup options in the menu tree and within setup and application screens.

An On/Off power key is located at the lower right of the front panel. The On/Off power key is enabled and disabled by a jumper on the main board.

2 Operation

2.1. Overview

This chapter provides information about navigation, basic functionality, and report generation using the IND560x terminal.

Operation of the terminal depends on enabled functions and parameters that are configured in setup as described in Chapter 3, Configuration. Navigation and basic functionality, as well as basic report generation are covered in the following sections.

2.2. Security

The IND560x supports the use of username/password for setup security at four levels.

2.2.1. Administrator

An Administrator has unlimited access to all areas of the operating and setup system. There can be multiple Administrator accounts. There is a Primary Administrator account, which can be changed but never deleted. The terminal is pre-configured at the factory with the Primary Administrator account with a username of "admin". The factory default password is null (no password). The pre-configured username (admin) cannot be changed; the password can only be added or modified. The unit as configured at the factory requires no login or password entry to enter the setup mode. All functions of the terminal are available to all users until a password for the Primary Administrator account is set up.

When the Metrology switch (SW1-1) is turned "on" (refer to the next section of this chapter) and a region approval is selected in setup, all users with Administrator rights are reduced to the Maintenance level. This is done to protect metrologically significant parameters that cannot be changed when the terminal is approved.

Similarly, the metrology switch can also be used to prevent Administrator level users from accessing metrology features even if the region approval is "None".

- Once a password is set up, be sure to remember the password. If the password is changed or forgotten, access to the setup menu will not be available. Be sure to protect the password from access by unauthorized personnel. The password provides access to the entire setup menu, unless the metrology switch is placed in the approved position.

2.2.2. Maintenance

Access can be limited by configuring this security level as desired.

2.2.3. Supervisor

Access can be limited by configuring this security level as desired.

2.2.4. Operator

One default operator account with a username of anonymous and password null (no password) is provided. Sites with validation requirements might create many operator accounts, each with a username and password entry requirement.

2.2.5. Password

If a password has been programmed for the Primary Administrator username in Setup, a security challenge is presented when entering Setup and a username and password must be entered. The user can enter a password at any security level supported by the User configuration in the User setup.

The terminal is pre-configured at the factory to include an "anonymous" user account with a null (blank) password. The default anonymous user record can be edited or deleted. The user can increase to a higher level of security clearance by requesting a setup function and then meeting the associated security challenge.

If a login fails, the display exits the login page and returns to the home position.

2.2.6. Metrology Switch

If the metrology switch (SW1-1) is placed in the approved position (On) access to the Scale branch of setup and other metrologically significant areas is not permitted. The metrology switch can be used to prevent Administrator level users from accessing metrology features even if the region approval is "None".

Selecting a specific region approval and turning "on" the Metrology switch specifically alters some scale functions:

- If the approval is Canada, then the keyboard tare command carries out a rounded tare.
- If the approval is Canada, then the center of zero division is 0.2d. The default value for non-approved mode is 0.25d.
- If the approval is OIML, then the power up zero range is +/- 10% and pushbutton zero range is +/-2%. For non-approved mode, this range can be selected by the user.
- If the approval is Argentina, terminal functions are changed as follows:
 - Access to the setup screens is prohibited while the metrology switch is engaged. If an attempt is made to access the setup menu, a message is displayed that says "Access denied. Scale is Approved."
 - All shared data server write ability via COM1 (serial) and Ethernet is disabled. Information can still be read from shared data, but writing to shared data is not possible.
 - The FTP server (both serial and Ethernet) can only read files from the terminal. It cannot write anything to the terminal. Shared data field nf0101 will automatically be set to 2.

- If SICS is selected as an assignment for a port, all SICS commands must be disabled. When a SICS command is received, an “EL” response is returned.
- A preset tare from the front panel, from the tare table, received serially (for example 1.00T via the CTPZ input assignment) or received from a PLC, can only be accepted if there is no motion on the scale. If motion is detected, the terminal should wait for the programmed stability timeout period and, if the motion continues, discard the request. The preset tare feature will therefore operate just like the semi-automatic tare feature.

Access to the metrology switch may be sealed in conformity with local regulations in “legal-for-trade” applications. Figure 2-1 shows the location of the metrology switch.

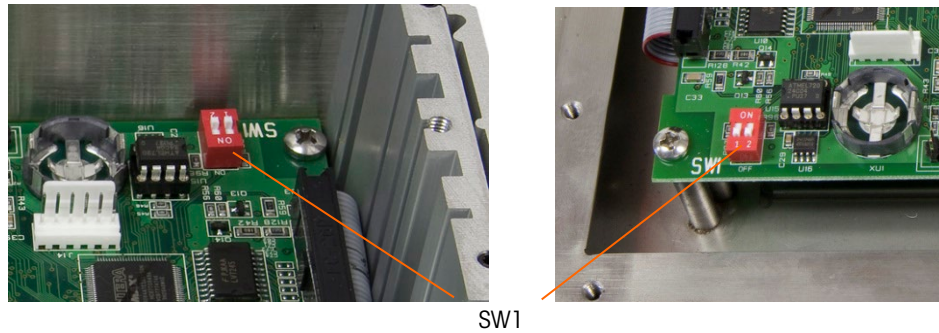



Figure 2-1: Metrology Switch Location, Panel (left) and Harsh (right)

- Refer to the Installation Manual, PCB Switch Settings, for further information about SW1-1 and SW1-2 switch settings.

2.3. Display Operation

Key names and commands are identified in this manual by upper- and lower-case letters. Key names, such as ENTER, are in all upper-case letters, and commands, such as “select,” are in lower-case (unless they begin a sentence, in which case the first initial is upper-case). For example:

“Press START...” means to press the START softkey .

“Select an option...” means to use the UP or DOWN navigation keys to select a setting, then press ENTER.















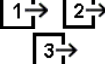



2.3.1. Softkeys and Icons

Softkeys and application displays use graphic icons for identification. Table 2-1 shows graphic icons and their functions, categorized by where they are used. Items with an asterisk (*) require a supervisor level log-in or above to be in effect.

Table 2-1: Icons and Functions

Icon	Function	Icon	Function
Information Recall Options			

Icon	Function	Icon	Function
	Clear All*		Recall information
	Clear Subtotal*		System Information Recall
	Metrology Recall		Total Recall
	Print*		Weight Recall
Softkey Menu and Setup			
	Enter Setup Menu		More Softkey Selections (scroll rows up and down)
Calibration Icons			
	CalFREE™ Calibration		Capture Zero
	Capture Span		Step Calibration
	Service Mode (access the IDNet service mode)		Start
	Run Calibration Test		Test Weight Information
	Skip (skips failed Calibration Test step and continues with the test)		
Table, Memory and Function Access			
	Tare Memory (access the tare table)		Target Memory (access the target table)
	Alibi Memory		Target (view or edit active record values for the target comparison)
	View Table (access a table to view or retrieve a record)		Search (begin the search of a table for a record or group of records)
	Tare (captures live scale weight into the tare record – Tare Table edit only)		Comparators (view and edit Comparator Limit values)

Icon	Function	Icon	Function
	Reports (recall and print reports for Alibi Memory, Tare Table, or Target Table)*	ID	ID (initiates a programmed transactional sequence)
123	Transaction Counter	000	Reset Counter
	Time & Date		Print
	Repeat Print		Customized Print Triggers 1, 2 and 3
Editing			
C	Clear All*		Exit (return to previous screen)
	Delete		Insert
	Edit		Validate Entry/Transaction (OK)
Esc	Escape (exit without storing)		Copy
Display Icons			
x10	Times 10 Display (expands the displayed weight by 10)	Smart-Trac	SmartTrac (turns SmartTrac display off and on)
Min-Weigh	MinWeigh (enter MinWeigh mode)		Unit Switching
	Adjust Contrast		
Special Control			
	Target Control		Start
	Pause		Stop
	No	C*	Clear Total*
	Reset		

Task Selection Icons (only when TaskExpert™ is installed)	
Icon	Function
	Task List Displays list of assigned TaskExpert applications
	Task 1 Starts TaskExpert application designated as Task 1
	Task 2 Starts TaskExpert application designated as Task 2
	Task 3 Starts TaskExpert application designated as Task 3

2.4. Understanding the Navigational Interface

Navigate in the applications and configure the IND560x using

- Navigation keys
- Soffkeys
- Scale function keys
- Alpha keys
- Numeric keys

The locations of these keys and the display screen area are shown in Figure 2-2.

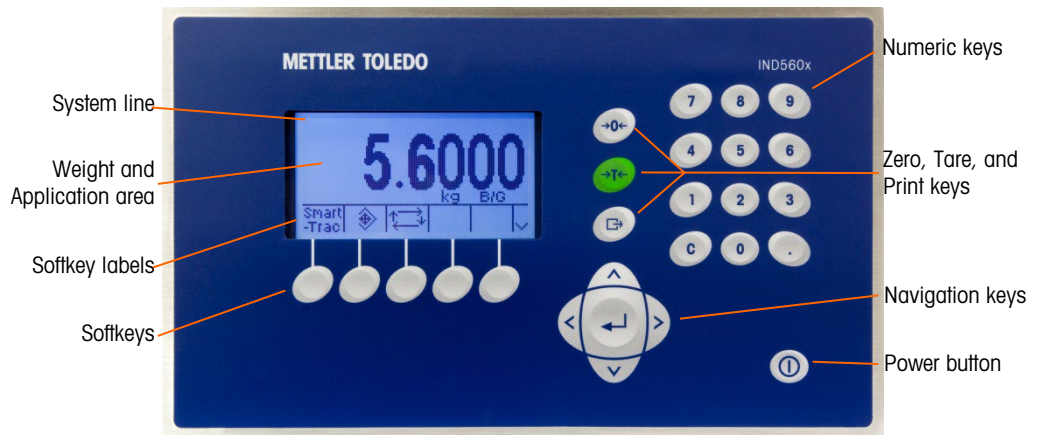

Figure 2-2: Key Locations and Display Screen

2.4.1. Navigation Keys

Navigation keys (see Figure 2-2) enable navigation within the setup menu tree, setup screens, and application screens. Navigation keys include:

- UP and DOWN navigation keys
 - Moves the focus up or down to different setup options within the menu tree (focus is indicated by highlighted text), to different fields within a setup page, and to switch to another page of available soffkeys. The UP and DOWN navigation keys are also used to move to a next or

previous page when a scroll bar indicates that two or three pages are used for configuration fields associated with a specific parameter. The example in Figure 2-3 shows a configuration parameter that requires two pages to display all of the associated configuration fields. The scroll bars indicate which page of the two is displayed.

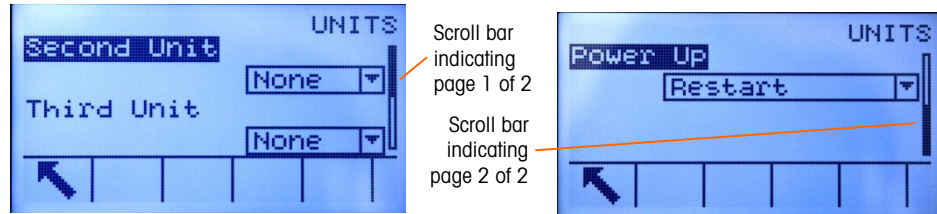

Figure 2-3: Example of Scroll Bars, Indicating Two Pages of Configuration Fields

Press the DOWN navigation key to move from page 1 to 2, Press the UP navigation key to move from page 2 to 1.

- LEFT and RIGHT navigation keys
 - Expand (RIGHT navigation key) the setup options in the menu tree
 - Collapse (LEFT navigation key) the setup options in the menu tree
 - Move the cursor position to a specific character in text areas
 - Enable left and right scrolling to view all information available on a screen
- ENTER key
 - Opens the setup page for viewing and editing setup parameters
 - Moves the focus from a field label to a setup value for that field
- Accepts new values entered in a field and moves the focus to the next field label

2.4.2. Softkeys

There is a softkey setup page that is used to

- Change softkey positions
- Enable softkey functions
- Disable softkey functions

For example, a UNIT SWITCHING softkey  can be enabled for selecting alternate units of measure.

Five softkeys are located along the bottom of the display screen (see Figure 2-2). Some applications might have up to three pages of softkeys for a total of 15 possible functions. A MORE DOWN symbol  displayed on the lower-right corner of the screen (to the far right of the softkey icons) indicates that more softkey selections are available. Press the DOWN navigation key to display additional softkey screens, and UP to display the previous softkey screen.

2.4.2.1. Customizing Softkeys

All the softkeys available for assignment to the home screen can be replaced with customized bitmap images.

The bitmaps must measure no more than 23 pixels wide by 15 pixels high. Each graphic must have a white border at least one pixel wide at left, right and top – see Figure 2-4.

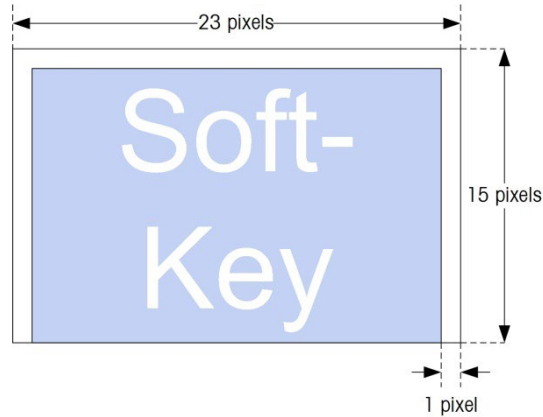







Figure 2-4: Softkey Graphic Dimensions

Graphics may be uploaded to the IND560x terminal using an ftp connection via Ethernet, or through a serial port.

New bitmap graphics must have the same filename as the graphic they replace. Table 2-2 lists the softkey graphics that can be replaced with customized images.

Table 2-2: Bitmap Graphic Filenames

Softkey	Default Image	Graphic File Name
Alibi	Alibi	alibi.bmp
Calibration Test		cal_test.bmp
Comparators		comprtr.bmp
ID	ID	ld.bmp
MinWeigh	Min-Weigh	minweigh.bmp
Recall Info		recall.bmp
Reports		reports.bmp
Setup		setup.bmp
SmartTrac	Smart-Trac	sm_trac.bmp
Tare Table		tare_mem.bmp
Target		target.bmp
Target Control		control.bmp
Target Start		start.bmp
Target Table		targ_mem.bmp

Softkey	Default Image	Graphic File Name
Trigger 1		trigger1.bmp
Trigger 2		trigger2.bmp
Trigger 3		trigger3.bmp
Time & Date		timedate.bmp
Unit Switching		select.bmp
X10 Display	x10	x10.bmp

2.4.3. Scale Function Keys

Scale function keys (see Figure 2-2) are:

→0← ZERO When the scale platform or weighbridge is empty, the terminal should indicate zero. The gross zero reference is recorded during calibration. Press the ZERO scale function key to capture a new gross zero reference point if pushbutton zero is enabled in configuration and the weight is within the zero range.

→T← TARE Tare is the weight of an empty container. Tare is normally used to determine the net weight of the contents of a container. Press the TARE scale function key when an empty container is on the scale. The terminal then displays a zero net weight. As the container is loaded, the terminal then displays the net weight of the contents. Pushbutton tare must be enabled to use this key in this manner.

When the empty weight of the container is a known value, enter the tare weight using the numeric keys and then press the TARE scale function key. The terminal will display the net weight of the contents of the container. Keyboard tare must be enabled in order to use this key in this manner.

→G→ PRINT Press the PRINT scale function key to initiate a demand print of an assigned print template. A serial or Ethernet print connection must be configured to link a template or report to the selected serial or Ethernet port. When a print command is issued, Printing appears in the system line for 5 seconds – see Figure 2-9.

2.4.4. Alpha Keys

On some setup pages, softkeys function as alpha keys (see Figure 2-5) that are used to enter alphabetic characters for setup parameters such as passwords.

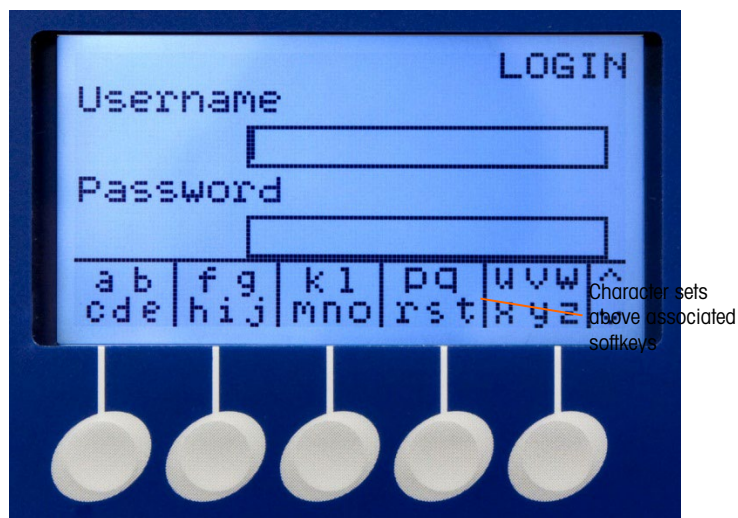

Figure 2-5: Alpha Keys

The alpha keys are automatically displayed when the cursor is moved into a data entry box that supports alpha entry. The first set of softkeys shown is upper-case letters (Figure 2-5). Three additional sets of softkeys include lower-case letters and symbols. In each of these sets, a group of four to six characters is shown per softkey.

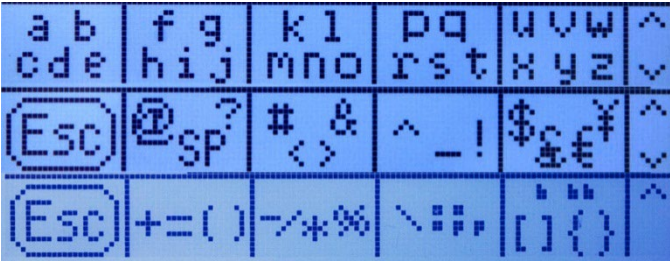

Figure 2-6: Additional Character Sets

To enter a character, use the UP and DOWN arrow keys to move to the row of keys that shows the group including the desired character. If the set of keys shown does not include the required character, press the DOWN navigation key to view the next set. Press the DOWN navigation key and UP navigation key as required until the set of keys shows the required character. The presence of the MORE UP / MORE DOWN symbols to the right of the softkeys indicates that additional sets of characters are available. Once the correct row is showing, press the softkey under the group of characters that includes the required character.

At this point, the characters above the softkey will change to show one character per softkey (Figure 2-7).

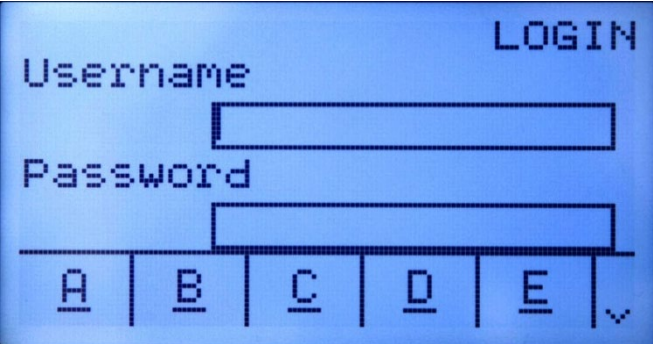

Figure 2-7: One Letter Per Softkey

Now, press the softkey that corresponds to the desired character. Also note that the MORE DOWN symbol is shown at the right of the softkeys. Press the DOWN navigation key to view the second row of characters. This group will include an ESCAPE softkey (Esc) (Figure 2-8). If the wrong group of characters was selected, use this softkey to return to the character set selection screen.



Figure 2-8: ESC Character

Repeat this process until all alpha characters have been entered. The CLEAR key can be used to delete unwanted characters in the entry box. The ESCAPE softkey (Esc) on the symbol group of softkeys (see Figure 2-6) exits the data entry process without accepting any of the new data typed.

The data in the entry field will revert to the original data (that was in the entry box before the new entry was initiated).

Once desired alpha characters have been entered in appropriate fields on the screen, press the ENTER key to accept the entries.

2.4.5. Numeric Keys

Use the terminal's 12-key numeric keypad (see Figure 2-2) to enter data and commands.

To use numeric keys, position the cursor in the field (see Navigation Keys) and press the numeric keys to enter the appropriate data. Press the DECIMAL key to enter decimal points where necessary.

The CLEAR key functions like a backspace key. Position the cursor at the end of data to be deleted and press the CLEAR key. Press the CLEAR key once for each character to be deleted. When first entering a data entry box, the previous entry will be in focus. Pressing CLEAR at this point will clear the entire previous entry.

2.5. Home Screen

The Home screen displays when the terminal is idle. The Home screen is the only screen that provides operator access to the programmable softkeys. Figure 2-9 shows a sample screen with a message showing in the system line.



Figure 2-9: Default Home Screen, System Line with Message Showing

The Home Screen includes:

- **System Line** Displays system messages and application data
- **Application Area** Displays weight, units, and other application-specific weighing data
- **Softkey Icons** Displays the icons for the active softkey functions. The appearance of a MORE DOWN symbol ∨ or a MORE UP ^ symbol indicates that more softkey selections are available

2.6. Basic Functionality

This section provides information about the IND560x's basic functionality. Additional areas of functionality specific to application software available for the IND560x are addressed in the specific application manuals. Basic functions addressed in this section include:

- External Battery Compatibility
- Zero
- Tare
- Unit Switching
- Expand By 10
- Print
- MinWeigh
- Information Recall
- Target Comparison
- Comparators
- ID Mode
- SmartTrac
- Time and Date
- Reports
- Calibration Test
- CalFREE™
- Alibi Memory
- Table Searches
- Remote Display
- ACM500 Reconnect

2.6.1. Compatibility with External Battery Pack

An external NiMH battery pack is available as a power option for the harsh/analog model of the IND560x terminal. Only the METTLER TOLEDO NiMH battery pack, part # 64060625, is approved for use with the IND560x. The IND560x terminal requires a specific software configuration to enable system compatibility with NiMH battery part # 64060625. Additional software parameters exist to help extend the single charge life of the battery.

These battery-specific settings are found in the following locations within the terminal setup menu. The settings can be addressed in the following order to ensure proper setup for external battery compatibility.

2.6.1.1. Scale > Type

Load Cell parameters are shown only for IND560x analog main boards and only if scale type is selected as Analog. The Load Cell parameter default values are 1 x 350 Ω. If scale type is set as Remote, the number of cells is automatically set to 0.

- These settings are shown in the Setup menu for all analog terminals whether support for the battery has been enabled or not. However, only the harsh/analog model is physically capable of supporting the external NiMH battery.

It is important to enter the correct values for the Load Cell parameters, as the current demand from the load cells determines the switch off voltage set point of the external battery. Setting the Load Cell parameters correctly helps to:

- Ensure that all the available capacity of the battery is being utilized
- Protect the battery pack from a deep discharge that will harm the NiMH cells and shorten the lifespan of the pack

2.6.1.2. Terminal > Device > Battery Operation

This parameter is only shown in IND560x models with analog main boards. The default value is Disabled. Setting this parameter to Enabled will trigger the IND560x to use the Load Cell parameters

established at Scale > Type. Enabling Battery Operation also unlocks an Auto Power Off parameter elsewhere in the Terminal branch of the Setup menu.

2.6.1.3. Terminal > Display

Once the Battery Operation parameter has been set to Enabled, users can choose to activate an auto-power off feature that will help to optimize single charge battery life. The Auto Off Timer parameter monitors scale motion and keypad operation. If no keypad activity occurs within the selected time value, the terminal automatically turns itself off. This auto-shutdown will occur with no warning to the operator.

2.6.1.4. Recommendations for Battery Powered Systems

Battery powered systems of all types should always avoid unnecessary power consumption. The following recommendations should be used whenever possible to prolong the single charge life and long term performance of the METTLER TOLEDO NiMH battery pack (P/N 64060625).

2.6.1.4.1. IND560x System Hardware Considerations

- Use high impedance scale bases and load cells when possible. When considering only NiMH battery single charge life, 1,000 Ohm load cells are preferred over 350 Ohm load cells. Single charge battery life will increase as load cell impedance increases.
- Only install options and connections that are required. If an option board has multiple connections, only physically connect the ports that are required. (e.g. if only COM4 is required, do not make a physical connection to COM5 also).

2.6.1.4.2. IND560x Software Considerations

- Enable Battery Operation at Terminal > Device > Battery Operation
- If feasible, enable the Auto Power Off setting at Terminal > Device > Auto Power Off
- If backlight is enabled, enable the Backlight Timeout setting found at Terminal > Device > Display.
- Disable all unnecessary communications that might be configured at Communication > Connections. This includes communications on COM4, COM5 or COM1.

2.6.1.4.3. General NiMH Battery Handling

- Recharge the NiMH battery as soon as possible after a "low battery" warning is seen on the screen of the IND560x terminal.
- Rechargeable batteries self-discharge. To prevent the NiMH battery packs from experiencing a damaging deep discharge, establish a quality control process to recharge them every three months, even if not in use.
- Do not store or charge the NiMH battery packs in hot places. High temperatures increase the rate of self-discharge.

2.6.1.4.4. Estimated Single Charge Battery Life

When users implement the recommendations listed above regarding IND560x hardware and software, as well as the general NiMH battery handling recommendations, the estimated single charge life of Mettler Toledo's NiMH battery pack (P/N 64060625) in various IND560x applications is shown in Table 2-3.

- All estimates assume use of a new, freshly charged NiMH battery pack (NiMH batteries experience up to 5-10% self-discharge in first 24 hours following charge.)
- All estimates assume use at 20°C
- Approximate recharge time 6 is hours
- 500 recharge cycles is lifetime expectancy of NiMH battery pack P/N 64060625. Reduced runtime will occur at the end of battery lifetime.

Table 2-3: Estimated NiMH Battery Single Charge Life

Total Load Cell Resistance (TSR)	Installed IND560x Hardware Options	Approximate Current Consumption	Estimated Operating Time
87.5Ω	No options OR A/P Discrete I/O Only*	265 mA	25 hours
350Ω		225 mA	32 hours
1000Ω		215mA	35 hours
87.5Ω	CL or FO with or without A/P Discrete I/O*	275mA	24 hours
350Ω		240mA	30 hours
1000Ω		230mA	32 hours

* The influence of the A/P Discrete I/O on overall operation time is negligible.

2.6.1.4.5. Low Battery Warnings and Battery Protection

When the battery voltage reaches a pre-defined value, a “Low Battery!” message will appear in IND560x system information line, blinking at three second intervals. The terminal will continue to operate for one hour or less (depending on system configuration and battery condition) after the “Low Battery!” message appears. During this period, turn the terminal off and either remove and charge its battery, or replace the battery with a fully-charged one.

- Note: Performance of the NiMH battery will be reduced if it is allowed to discharge too deeply. The low battery warning and shut-off functions are designed to protect the battery’s efficiency and life-span.

If the shut-off voltage is reached before the battery is recharged or replaced, a message will appear on screen – “ALARM – Low Battery! Power off is in process!”. This message will display for ten seconds, after which the terminal will power off automatically.

2.6.2. Zero

The Zero function is used to set or reset the initial zero reference point of the IND560x. There are three types of zero setting modes:

- Automatic Zero Maintenance
- Power-Up
- Pushbutton

2.6.2.1. Automatic Zero Maintenance

Automatic Zero Maintenance (AZM) enables the IND560x to compensate for the buildup of small amounts of weight and track itself back to the center of zero. Within the AZM operating range (programmable from 0.00 to 10.00 divisions), when the terminal is in a no motion condition, it makes small adjustments to the current zero reading to drive the weight reading toward the true center-of-zero. When the weight is outside of the programmed AZM range, this feature is not functional.

2.6.2.2. Power-Up Zero

Power-Up Zero enables the IND560x terminal to capture a new zero reference point after power is applied. If there is motion during a power-up zero capture function, the terminal will continue to check for a no-motion condition until zero is captured.

Power-up zero can be disabled or enabled, and a range above and below calibrated zero can be configured. The range is programmable from 0% to 100% of capacity and can include a positive range and also a range below calibrated zero.

2.6.2.3. Pushbutton Zero

The pushbutton (semi-automatic) zero function can be accomplished by pressing the ZERO →0← scale function key, programming a discrete input, a PLC command or serial command, or by an application.

The range for all types of semi-automatic zero is selectable (0% to 100%) plus or minus from either the calibrated zero point (if power-up zero is disabled) or from the initial zero setting point (if power-up zero is enabled).

Remote initiation of the semi-automatic Zero command is possible via a discrete input, an ASCII 'Z' command sent serially (CPTZ and SICS), a command initiated by the PLC interface, or from an application.

2.6.3. Tare

Tare is the weight of an empty container. A tare value subtracts from the gross weight measurement, providing the computation of the net weight (material without the container). The tare function can also be used to track the net amount of material being added to or removed from a vessel or container. In this second case, the weight of the material in the container is included with the tare weight of the container as tare. The display then reflects the net amount being added to or removed from the vessel.

Tare types and associated operations available on the IND560x include:

- Pushbutton Tare
- Keyboard Tare (Preset Tare)
- Net Sign Correction
- Auto Tare
- Tare Clear
- Manual Clear
- Auto Clear

2.6.3.1.

Pushbutton Tare

Pushbutton tare can be configured in setup as enabled or disabled. When disabled, the TARE scale function key $\rightarrow T \leftarrow$ cannot be used to obtain a tare.

If enabled, pressing the pushbutton TARE scale function key $\rightarrow T \leftarrow$ initiates a semi-automatic tare. The IND560x will attempt to perform a tare process. If successful, the display changes to a zero net weight indication and the previous weight on the scale is stored as the tare value. The net mode will be indicated on the display.

Several conditions could inhibit the pushbutton tare function:

- Motion – Pushbutton tare cannot be taken when the scale is in motion. If motion is detected when a pushbutton tare command is received, the IND560x will wait up to three seconds for a no-motion condition. If a stable (no motion) weight condition occurs before the three seconds expire, the pushbutton tare command is executed.

If there is still motion at the end of three seconds, the command is aborted and a “Tare Failure–In Motion” error displays.

- Pushbutton Tare Disabled – If pushbutton tare is configured as disabled, the TARE scale function key will not initiate a semi-automatic tare.
- Negative Gross Weight – Any pushbutton tare attempted when the gross weight is at or below zero is ignored and a “Tare Failed–Too Small” error displays. Ensure that the gross weight is above zero.

2.6.3.2.

Keyboard Tare

A keyboard (preset) tare is a numeric tare that is entered manually through the numeric keypad, received serially from a peripheral, or retrieved from the Tare Table memory. The preset tare value cannot exceed the capacity of the scale. Data entered is interpreted to have the same units as the current displayed value. Motion does not impact the entry of preset tare values.

Keyboard tare can be configured in setup as enabled or disabled. When disabled, the numeric keypad and the TARE scale function key $\rightarrow T \leftarrow$ cannot be used to obtain a tare.

To enter a preset tare value manually, use the numeric keypad to enter the tare value (the data entered will display above the softkey with a Data: label) and press the TARE scale function key $\rightarrow T \leftarrow$.

If configured in setup, remote equipment can enter a preset tare value using a serial command or PLC command (Refer to Chapter 3, Configuration, the Communication section, Serial and PLC setup, for further information).

If the preset tare is successful, the display changes to a net weight indication, and the entered preset tare value is stored as the tare value in the Tare Table.

Several conditions could inhibit the preset tare function:

- Keyboard Tare Disabled – If keyboard tare is configured in setup as disabled, the numeric keypad and the TARE scale function key $\rightarrow T \leftarrow$ cannot be used to obtain a tare.

- Over-Capacity or Under-Zero Conditions – Preset tare is not allowed when the weight display indicates over capacity or under zero conditions. Any preset tare attempted when the scale is over capacity is ignored and a “Tare Failed–Over Cap” error displays. Any preset tare attempted when the weight display indicates an under zero condition is ignored and a “Tare Failed–Too Small” error displays.

Preset tare can be entered in free format. If the entered value does not match the displayed weight decimal point location or display interval, the entered tare value is rounded to the nearest display interval and the decimal point adjusted to match the gross weight. The rounding method is that 0.5 or more of a display interval (d) is increased to the next display interval and 0.49 or less of a display interval is decreased to the next lower display interval.

When entering a preset tare value less than 1.0, the operator can enter the data without the leading zero (left of the decimal point), but all subsequent display, storage, or printing of this value will include the leading zero. For example, a preset tare entry of .05 will display as 0.05.

If a preset tare has already been established and another preset tare is entered, the second preset tare replaces the previous value (it does not add to the previous value). The replacement tare can be larger or smaller than the original tare value.

2.6.3.3. Tare Table

The IND560x terminal contains a tare table with 25 records for storing tare weights that can be recalled by the operator, instead of manually entering them for each transaction. This is especially useful when certain tare values are used repeatedly.

A 20 character description can be included for each record. This can be used to help distinguish one tare record from another. Each tare record in the tare table also contains a totalization field. When totalization is enabled for the tare table, each time a transaction is completed using a specific tare ID, the selected weight value (gross or net weight) will be added to the total and the corresponding counter will be incremented by one.

A tare memory can be recalled by either picking from a list of all available records or if the ID for the tare value is known, it can be “quick” accessed (refer to the Quick Access section, below). A printed report of the records in the Tare Table is also available.

2.6.3.4. Net Sign Correction

Net sign correction enables the terminal to be used for both shipping (inbound empty) and receiving (inbound loaded) operations. Net sign correction can be either disabled or enabled on the IND560x. Refer to Chapter 3, Configuration, the Scale section, for further information about disabling and enabling net sign correction.

If net sign correction is disabled in setup, any stored weight value in the tare register is assumed to be a tare regardless of the gross weight present on the scale at the time of the final transaction and net values can be negative.

If net sign correction is enabled, the terminal will switch the gross weight and tare weight fields when necessary, so that the larger weight is the gross weight, the smaller weight is the tare weight, and the difference is always a positive net weight. Net sign correction affects the display, stored data, weight recall, and printed data.

Net sign correction will operate with pushbutton tare, preset tare, or tare memories. An example of weight values with and without net sign correction is shown in Table 2-4. In this example, the tare register value is 53 kg and the live weight on the scale is 16 kg.

Table 2-4: Weight Values With and Without Net Sign Correction

Printed and Displayed	Net Sign Correction	
	Disabled	Enabled
Gross	16 kg	53 kg
Tare	53 kg	16 kg
Net	-37 kg	37 kg

- When net sign correction is enabled, the tare weight field in the recall display will be labeled with the letter “M” to indicate “Memory” instead of “T” or “PT”.

2.6.3.5. Auto Tare

The IND560x can be configured so that tare is automatically taken (auto tare) after the weight on the scale exceeds a programmed tare threshold weight. Auto tare can be configured in setup as enabled or disabled. When auto tare is enabled, the display changes to a zero net weight indication after the weight exceeds the threshold value. The previous weight on the scale is stored in the Alibi Table as the tare value. Auto tare operations involve:

- Tare Threshold Weight – When weight on the scale platform exceeds the tare threshold value, the terminal automatically tares.
- Reset Threshold Weight – The reset threshold weight must be less than the tare threshold weight. When the weight on the scale platform falls below the reset threshold value, such as when a load has been removed, the terminal automatically resets the auto tare trigger.
- Motion Check – A motion check is provided to control the re-arming of the auto tare function. If disabled, the auto tare trigger will be reset as soon as the weight falls below the reset value. If enabled, the weight must settle to no-motion below the reset threshold before the next auto tare can be initiated.

Several conditions could inhibit the auto tare function:

- Motion – Auto tare cannot be taken when the scale is in motion. If motion is detected after the weight on the scale exceeds a preset tare threshold weight, the IND560x will wait for a no-motion condition. If a stable (no motion) weight condition occurs within three seconds, the auto tare command is executed.
- Auto Tare Disabled – Auto tare can be configured in setup as enabled or disabled.

2.6.3.6. Clearing Tare

Tare values can be cleared manually or automatically.

2.6.3.6.1. Manual Clear

Manually clear tare values by pressing the CLEAR key **C** on the numeric keypad when the IND560x is in the net mode and has completed the weighing operation. Motion on the scale will not impact a manual clear.

If configured in setup, pressing the ZERO scale function key $\rightarrow 0 \leftarrow$ will first clear the tare, then issue a zero command (Refer to Chapter 3, Configuration, the Scale section, Auto Clear).

2.6.3.6.2. Auto Clear

The IND560x can be configured to clear tare automatically when the weight returns to a value below a programmable threshold, or when a print command is issued. Once the tare is cleared, the display returns to the gross weighing mode.

Auto clear is disabled or enabled in setup. If auto clear is enabled the following parameters, configured in setup, affect the auto clear operation:



- **Clear Threshold Weight** – The clear threshold weight is the gross weight value below which the IND560x will automatically clear a tare after settling to a value above this threshold value.
- **Motion Check** – A motion check is provided to control the automatic clearing of tare. If the motion check is disabled, the tare value is cleared as soon as the weight drops below the threshold weight (auto clear threshold), regardless of the motion status.

If the motion check is enabled, after meeting the requirements for weight value above and then below the threshold weight (auto clear threshold), the IND560x waits for a no-motion condition before automatically clearing the tare.
- **Clear After Print** – If enabled, tare is automatically cleared and the scale returned to the gross mode after data has been transmitted by pressing the PRINT scale function key  or from a remote source.

Refer to Chapter 3, Configuration, the Scale section, Auto Clear for further information about configuring auto clear.

2.6.4. Unit Switching

In order to support locations and applications that utilize multiple measurement units, the IND560x supports unit switching. The UNIT SWITCHING softkey  enables switching between primary units (the main unit of measure) and alternate units (second or third units).

When the UNIT SWITCHING softkey  is pressed, the display changes from the primary unit to the second unit. When this softkey is pressed again, the display switches to the third unit (if one has been programmed) or returns to the primary unit. Each subsequent time the UNIT SWITCHING softkey  is pressed the IND560x continues to switch the unit through the same sequence.

When units are switched, the units value changes to the correspondingly selected units, and the conversion of the display value occurs. The display division changes to an equivalent weight value in the switched unit (for example, from 0.02 lb to 0.01 kg) and the decimal location switches to accommodate the conversion.

When switching units, the capacity of the converted units is dictated by the original number of divisions established in the capacity and increments area of setup. In some situations, this may reduce the capacity of the terminal when converting to second or third units.

2.6.5. Expand By 10

The EXPAND BY 10 softkey **x10** is used to increase the selected weight display resolution by one additional digit. For example, a weight display of 40.96 could increase by one additional digit to display as 40.958. The Expand By Ten mode is indicated on the display by x10, which displays below the weight display. When the EXPAND BY TEN softkey **x10** is pressed again, the display reverts to the normal display of weight.

If programmed as approved with the metrology switch (SW1-1) ON, the Expand By Ten mode is displayed for five seconds then automatically returns to normal resolution. Printing is disabled when the weight is expanded and the terminal is programmed as approved.

2.6.6. Print

The print function (demand print) can be initiated by pressing the PRINT  function key on the main keyboard, by using custom print trigger softkeys or by automatic print settings. Demand printing of data may also be initiated as part of a particular sequence of operation or special application software. A 'Printing' system message (visible in Figure 2-9) appears for 5 seconds when the terminal is carrying out a print command.

2.6.6.1. Print Interlock

Print Interlock is designed to enforce a single print output per transaction. Print Interlock can be disabled or enabled. If enabled, the print command is ignored until the measured gross weight exceeds the print interlock threshold. After the first print command is executed, subsequent print commands are ignored until the gross weight indication falls below the print interlock reset threshold. If a print command is blocked by print Interlock, a synchronous "2nd Print Prohibited" error is generated and a "Print Not Ready" message appears in the system line.

2.6.6.2. Automatic Print

Automatic initiation of a demand print occurs after the gross weight exceeds the minimum threshold and there is no motion on the scale. After initiation, the gross weight must return below the reset threshold before a subsequent automatic print can occur.

Automatic print may be disabled or enabled. Automatic print can be triggered and reset by weight exceeding thresholds or by weight deviation from a previously stable reading.

2.6.6.3. Repeat Print

The Repeat Print softkey  permits the output of the most recent Demand Print or a Custom Print from an application, to be printed again with a DUPLICATE header or footer to distinguish it from the original print.

To enable the Repeat Print function, simply add the Repeat Print softkey  to the Home Page. Pressing this softkey will initiate a repeat print of the last Demand Print connection listed in the assignments found in Setup at Communication > Connections.

An output template can be flagged with a "DUPLICATE" header or footer to indicate that the data in the output template was generated as a repeat of a previous communication.

2.6.6.4. Custom Print Trigger

The three custom print triggers  available in the IND560x function like the standard demand print, except that they will not trigger alibi logging, totalization or transaction counter update.

- NOTE: This is a change in functionality introduced in v4.03 firmware. It affects how the IND560 handles print templates containing metrologically sensitive data.

With firmware versions 3.04 and earlier, the intended use of custom print triggers was simply to transmit non-metrological data from the terminal. Over the life of the IND560, it became apparent that custom print triggers were being used to transmit metrologically sensitive information such as weight data. However, in all firmware versions prior to v4.03, the custom print triggers were not subject to the same types of validity checks that the standard demand print was. Custom print triggers have historically been able to transmit metrologically sensitive weight data even under such circumstances as motion, over capacity, etc.

In terminals using v4.03 firmware, templates transmitted by a custom print trigger are evaluated for the following shared data types that indicate if the template contains metrologically sensitive scale information: ce, cs, tz, wk, wm, ws, wf. If the template includes any of these shared data fields, the following statuses are checked:

- Power Up Zero Not Captured
- Over Capacity
- Under Zero
- Data not OK
- Times 10 (x10) is enabled and terminal is in legal-for-trade mode
- Minimum print threshold not reached between print requests
- Print Interlock condition not met
- Motion

In v.4.03 firmware, except for motion each of these causes an immediate error. If there is motion, the terminal waits for the motion timeout period, and either prints (if stability is achieved) or displays an error.

2.6.7. MinWeigh

Certain industries such as pharmaceutical and food require a guarantee that the weighing equipment selected for a particular measurement is adequate for the task. One way to ensure that appropriate weighing equipment is selected is by the creation and use of a minimum weight value (MinWeigh), below which a particular piece of weighing equipment cannot be used.







When the MinWeigh function is enabled, the MINWEIGH softkey  can be pressed to initiate the MinWeigh function, which compares the current net weight with the programmed MinWeigh value. If the net weight is greater than or equal to MinWeigh, all equipment functions behave normally. If

the absolute value of the net weight is less than MinWeigh, the weight display includes a flashing MinWeigh symbol  to the left of the weight. If the user attempts to record the weight while in this condition, the printout will include an asterisk (*).

For specific step-by-step instructions on how to set up MinWeigh, Refer to Chapter 3, Configuration, Scale, MinWeigh.

2.6.8. Information Recall

Press the INFORMATION RECALL  softkey to access the recall screen where the softkeys shown below appear:

	Weight Recall	Displays the Gross, Tare, and Net active weight readings for the scale.
	System Information	Displays system information, including the model and serial number, Terminal ID #1, Terminal ID #2, Terminal ID #3, and software and hardware information. This ID information is entered in the Setup mode (Refer to the Chapter 3, Configuration, Terminal, Device, for more information about entering Terminal ID information).
	Metrology Recall	Displays the terminal metrology control number (MCN), whether the terminal is programmed as approved or not, and the last calibration time and date. On the high-precision IDNet version, the Ident Code (calibration tracking) is also displayed.
	Totals Recall	Displays the sub-total and grand-total transaction count and total weight for the terminal. Press the CLEAR SUBTOTAL softkey  to clear the sub-total amounts. Press the CLEAR softkey  to clear both the grand-total and sub-total amounts. Press the PRINT softkey  to print a report of the totals.

Notes: If either Clear Total or Clear Subtotal After Print is enabled in setup, these values will clear after printing.

Table clear and print functions are accessible only to users with Supervisor level log-in and above.

2.6.9. Target Comparison

Target comparison is used to compare either the gross or net weight on the scale to a predetermined target value. This feature can be useful in both automatic and manual processes. As an example, an automatic filling system using target comparison could provide a Start signal to the IND560x and the IND560x could control the feeder system to fill a container to a desired target.

An example of a manual process could be a checkweighing station where an operator is checking net weight of packages. The IND560x can use its target comparison feature to provide a bright Over - OK - Under indication to help the operator determine if the weight of each package is acceptable or not compared to an ideal weight.

Target (setpoint) comparison is most often used in two types of applications:

Material transfer applications – Requires that a control device deactivate when a target value is achieved

Over/Under applications – Classify a load placed on the scale platform as above or below the target value or within the target tolerance range



The IND560x target comparison rate (for analog load cell and SICSpro scales) is 50 comparisons per second. The comparison rate for high precision IDNet bases is dependent upon the module in the base.





Refer to Chapter 3, Configuration, the Application section, Memory, Target Table and Operation, Target for further information about configuring parameters for target comparison operations.

2.6.9.1. Material Transfer Applications



If the target comparison of the IND560x will be used to control the flow of material, the application can be classified as a Material Transfer application. These types of applications are usually automated but can also be manual. A single or two-speed feeding system is used to either add weight to or remove weight from the scale. The terminal monitors the change in weight and compares it to a previously entered target and other control parameters.





The following definitions explain some terms used in Material Transfer applications:

Abort	After a target comparison process has been paused, it can be totally stopped by pressing the Abort softkey  under the Target Control softkey  or by triggering a Target Pause/Abort discrete input. If abort is selected, the target comparison process is aborted.
Coincidence Outputs	A coincidence output is always active and does not require a start or stop signal. If the weight on the scale is below the target minus the spill value, the outputs are "on". If the weight is above the target minus the spill value, the outputs are "off". This type of output typically requires external logic to provide the required control for feeding systems.
Concurrent Outputs	This describes the operation of the feed output in a 2-speed feeding system. If the feeder type is programmed as concurrent, the feed output will turn on when the fast feed output turns on and continue to operate until the weight reaches the target minus the spill value. Both the fast feed output and the feed output are active at the beginning of a target comparison. It is the opposite of independent outputs.
Fast Feed Output	This refers to the physical output connection that is used for the faster feed in a 2-speed feeding system. This output is not used in a single speed feeding system.
Feed Output	This refers to the physical output connection that is used for the slower feed in a 2-speed feeding system or the only feed output in a single speed feeding system.
Fine Feed	The value entered for the amount of material that will be fed in the slower rate of feed in a 2-speed feeding system. This value and the spill value are subtracted from the target to determine the point that the fast feed output turns off.
Independent Outputs	This describes the operation of the feed output in a 2-speed feeding system. If the feeder type is programmed as independent, the feed output does not turn on until the fast feed output turns off. Only one feeder speed is active at a time. It is the opposite of concurrent outputs.
Latched Outputs	Latched outputs turn off at the target weight minus the spill value and remain off (regardless of additional weight changes) until a "start" signal is received. These types of outputs do not usually require external logic to perform standard weigh-in or weigh-out sequences.

Material Transfer Mode	The target comparison mode that provides control for delivering a measured amount of material from one container or vessel to another. The transfer can apply to material entering or leaving a container or vessel. It includes the traditional terms such as weigh-in, weigh-out, filling, and dosing.
Pause	A pause function is provided in target comparison control in case a target comparison must be temporarily paused. This can be done by pressing the Pause softkey  under the Target Control softkey  or by triggering a discrete input programmed as Target Pause/Abort. When paused, power is removed from the Feed and Fast Feed (if used) discrete outputs. After a target comparison has been paused, the process can either be resumed or aborted.
Resume	After a target comparison process has been paused, it may be resumed by pressing the Resume softkey  or by triggering a discrete input programmed as Target Start/Resume. When a target comparison is resumed, it continues to use the original target values.
Spill	The amount of material that will be added (on a weigh-in) or removed (on a weigh-out) from the scale after the final feed is turned off. In a weigh-in process, this is the material in suspension that will still fall onto the scale when the feed is turned off. This value is subtracted from the target value to determine when the feed output turns off.
Start	When using latched targets, the default condition is with the latch set or in the "off" condition. To turn any outputs "on", a start signal is required. This could be the Start softkey  , a discrete input programmed as Target Start/Resume, or via the Target Control softkey  .
Target	The target is the weight value that is the end goal of the material transfer process. If a container should be filled with 10 kg of material, the target value is 10 kg.
Tolerance	The weight range above and below the target value that will be acceptable as an "in tolerance" target comparison. The tolerance can either be entered as a weight deviation from the target or a percentage deviation from the target depending upon setup.

2.6.9.2. Target Control

Two different levels of target control are provided by the terminal for the Material Transfer mode. Latching outputs must be enabled to utilize either type of automated control. For simple applications, only the START softkey  is needed to begin the target comparison process. No other control is provided. The comparison runs to completion then the latch sets the outputs FALSE until the START softkey  is pressed the next time.

For those applications where more control is needed for an occasional pause or to abort a comparison process, the TARGET CONTROL softkey  is used. Pressing the TARGET CONTROL softkey provides a dedicated display for the target comparison with the comparison status and appropriate softkeys shown. Possible status modes are "Ready", "Running" or "Paused". The appropriate control softkeys include START , PAUSE  and STOP . An example of each target control display is shown in Figure 2-10, Figure 2-11 and Figure 2-12.

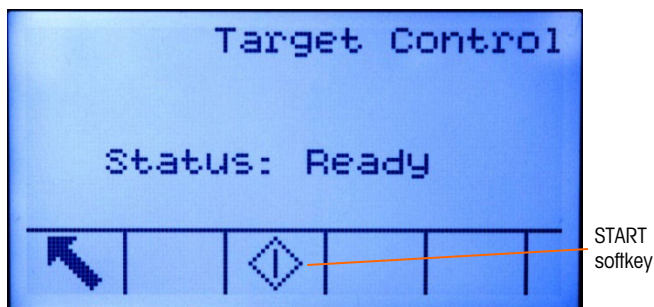

Figure 2-10: Example of Ready State in Target Control



Figure 2-11: Example of Running State in Target Control

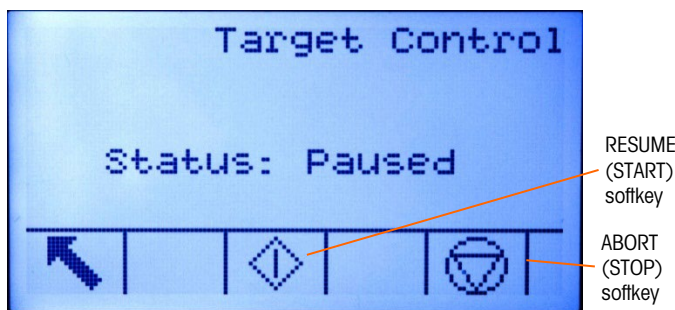

Figure 2-12: Example of Paused State in Target Control

2.6.9.3. Over/Under Applications

If the target comparison of the IND560x will be used to checkweigh the weight of a product, the application can be classified as an Over/Under application. These types of applications are usually manual processes but can also be automated. The SmartTrac display indicates the classification of the weight placed on the scale and discrete I/O can be used to trigger external lights or other controls. The terminal compares the current weight to a previously entered target with tolerance values or to zone limits and indicates the results. The following definitions will explain some terms used in Over/Under applications. The following definitions apply to over/under applications:

- Over Limit If a tolerance mode of "Weight value" is selected in setup, the IND560x does not require the entry of a target value. In this mode, only the upper and lower limits for the OK zone are entered. When programmed for this mode, the over limit value is the maximum weight that will be classified as OK. Any weight above than this value will be classified as Over.

Over/Under Mode	The target comparison mode that provides three zone classifications for weight placed on the scale. The classification can be Under if the weight is below the target minus the -tolerance, OK if within the tolerance range or Over if the weight is above the target plus the +tolerance.
Target	The target is the ideal weight value for the product being tested. If a container should weigh exactly 10 kg, the target value is 10 kg.
Tolerance	The weight range above and below the target value that will be acceptable as "OK" in the target comparison. The tolerance can either be entered as a weight deviation from the target, a percentage deviation from the target or as absolute weight (zone edges) depending upon setup.
Under Limit	If a tolerance mode of "Weight value" is selected in setup, the IND560x does not require the entry of a target value. In this mode, only the upper and lower limits for the OK zone are entered. When programmed for this mode, the under limit value is the minimum weight that will be classified as OK. Any weight below than this value will be classified as Under.
Zones	The IND560x provides 3 different classifications or "zones" in the Over/Under mode. The zones are Under, OK and Over.

2.6.9.4. Target Comparison Parameter Entry



To enter target comparison parameters, either directly edit the active records or load them with data from a record in the Target Table.

2.6.9.4.1. Direct Editing of Active Records

To directly edit the active record:

1. Press the TARGET softkey . (Refer to Chapter 3, Configuration, the Terminal section, Softkeys, for information about how to setup softkey display.) The Active Values screen displays.
2. Use the UP and DOWN navigation keys to scroll through the fields available for editing.
3. Press the ENTER key to select a field to edit.
4. Depending whether the mode is material transfer or over/under, and the type of tolerance selected, the active target record will show different fields to edit. Use the navigation and numeric keys to enter values for all of the fields as needed.

Material Transfer, Either Mode	Over/Under	
	Weight Deviation or % of Target	Weight Value
Target	Target	Over Limit
Spill	+ Tolerance	Under Limit
Fine Feed	- Tolerance	
+ Tolerance		
- Tolerance		

5. Use the alpha keys to enter a description.
6. Press the OK softkey  to accept the edits to the active record.
7. Press the ESCAPE softkey  to return to the weighing operation screen without saving the active record edits.

2.6.9.4.2. Loading Records from the Target Table





The TARGET MEMORY softkey  can be used in two ways to load records from the Target Table: Quick Access and List Selection.

Quick Access to Records

Use the Quick Recall mode when the ID of the Target Table record to be loaded is known. Use the numeric keypad to enter the ID and then press the TARGET MEMORY softkey  to load the record. If the record is available, the data is loaded. If the record is not found, an "ID not found" error displays.

List Selection

Use the List Selection mode when the ID of the Target Table record is unknown. To use the List Selection mode:

1. Press the TARGET MEMORY softkey  without any preceding data entry. The Target Search screen displays.
2. Enter any search restrictions required or leave selections as they are to retrieve all records.
3. Press the SEARCH softkey  to view the selected records in the table.
4. Use the UP and DOWN navigation keys to scroll through the list until the desired record is highlighted.
5. Press the OK softkey  to load the selected record from the list.
6. Press the ESCAPE softkey  to return to the weighing operation screen without loading the record.

Record Selection Using Shared Data

Alternatively, the Shared Data server can be used to activate target records stored in the Target Table. Refer to the Shared Data Reference found on the documentation CD for specific instructions.

Target Units

If second and/or third units are established in the IND560x, target records that utilize either second or third units can be retrieved from the Target Table into Active Target status. The IND560x will convert the retrieved record into active units when the record is recalled. Pressing the TARGET softkey  will show the original units as recalled from the Target Table.

If an attempt is made to retrieve a record from the Target Table that does not use primary, second or third units, a "Units Mis-match" error will display indicating that record recall was unsuccessful.

2.6.10. Comparators

Comparators are simple targets, five of which can be configured in setup. They are controlled either by coincidence or by comparison with a range. The source for comparison can be the Gross Weight, Displayed Weight, Rate or assigned by a custom TaskExpert application. When assigned to the home screen, the Comparator softkey  permits direct access to the Comparators. This screen displays each Comparator's ID, Description, Limit, Unit, High Limit (if applicable) and Active

operator. Only the limit value/s can be edited. To edit parameters other than limits, the Comparator configuration screen must be accessed in setup.

To access a comparator's limit editing page directly from the home screen, press the ID number of the Comparator, then the Comparator softkey. If the ID number is not known, press the Comparator softkey \rightarrow | \leftarrow , use the UP/DOWN keys to select the desired Comparator from the list, and press the Edit softkey .

- For range comparators, the High Limit value must always be higher than the Limit value.

When the Active value is $<$, \leq , $=$, \geq or $>$, the selected source is compared to a target weight. When the Active value is within ($> _ _ <$) or outside ($_ < _ >$) a range, the selected source is compared to a range defined by the Limit and High Limit values.

2.6.10.1. Using Comparators

To use a Comparator, it must be assigned to a discrete output.

2.6.10.1.1. Target Value Comparators

In this case, the output will be triggered depending on the Active setting. For example, if the Active operator is \leq (less than or equal to) and the Limit is 1000 kg, the output will turn OFF when the measured value reaches 1000 kg.

2.6.10.1.2. Range Comparators

In the case of a Range mode Comparator, the Limit value sets the lower of the two rates that define the range, within or outside (depending on the operator) which the output is active. For example, if the Active operator is Within ($> _ _ <$), the Limit is 3.0 kg/sec and the High Limit is 8 kg/sec, the output will be active provided the rate remains between 3 and 8 kg/sec. If the rate falls below 3 or exceeds 8 kg/sec, the output will turn OFF.

- Note that the Rate value configured in setup at Scale $>$ Rate permits weight and time units to be defined, together with the period between measurements and the number of measurements to average to generate the output value.
- If the weight information in the terminal becomes invalid, the Rate display will show 0.000.



A Range Comparator can also use displayed or gross weight as its source. For example, if displayed weight (possibly a net value, allowing for the weight of a hopper) is the source, the Active operator is Outside, and the Limit and High Limit are 1000 kg and 1500 kg respectively, the output will remain active as long as the source value is below 1000 kg. In this case a large enough value for the High Limit should be set to ensure that, once the Limit is reached and the output turned off, there is not sufficient spill to reach the High Limit and reactivate the output.

2.6.11. ID

The ID function provides a convenient and simple way to ensure that a specific sequence of operation is carried out the same way each time. Each step can include an on-screen message that instructs the operator to perform an action, or a prompt asking the operator to enter some information. These steps may include data entry (using the numeric keypad, alphanumeric keys, or some other input such as a barcode scanner) and actions (such as placing a package on the scale, taking a tare, or printing a ticket for the transaction). When a step is completed, pressing the ENTER key moves to the next one.

As many as 20 steps may be programmed, and the sequence can be triggered in one of two ways:

- Manually, using the ID softkey **ID**
- Automatically, by threshold and reset weight readings from the scale

If the sequence is triggered manually, it may be programmed to loop, repeating all steps until either the EXIT softkey  is pressed, or an ESC softkey  is pressed while an alphanumeric entry field is selected.

When ID mode is set to function automatically, placing on the scale a weight that exceeds a pre-configured threshold value initiates the sequence. When all the steps have been performed and the weight is removed, the reading from the scale falls below a reset value. At this point the terminal is ready to begin the next ID sequence.

For details on ID mode configuration, refer to Chapter 3, Configuration.

2.6.12. SmartTrac™

SmartTrac is a graphical display visualization of either the gross or net weight as selected in setup. SmartTrac on the IND560x uses a bar graph visualization type for Material Transfer mode and a three-zone graphic for Over/Under mode.

2.6.12.1. Material Transfer Mode

The operator adds material until the measured value is within an acceptable tolerance limit. Normally an operator will add material quickly when the container is not nearly full and more slowly as the target value approaches.

The SmartTrac display may be configured in setup as Small, Medium or Large. Each size provides different target and weight information on the display. Figure 2-13 shows the small size, Figure 2-14 shows the medium size, and Figure 2-15 shows the large size.



Figure 2-13: Material Transfer SmartTrac, Small





Figure 2-14: Material Transfer SmartTrac, Medium

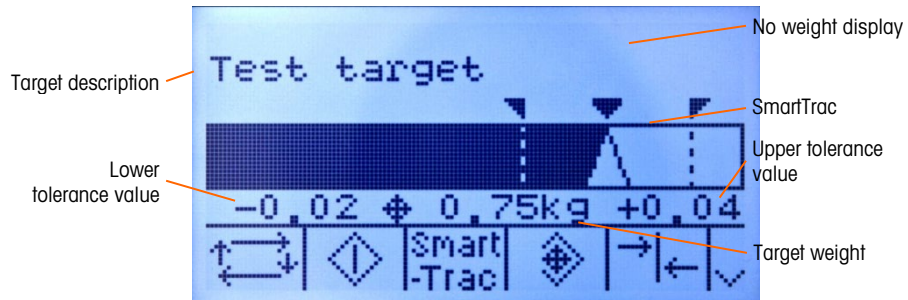

Figure 2-15: Material Transfer SmartTrac, Large

While the bar graph display appears to be one continuous bar graph, it can actually be broken into four separate sections or ranges. Depending upon the target and tolerance values used, there could be one, two, or three speeds at which these graphical sections are filled in. Figure 2-16 illustrates the ranges.

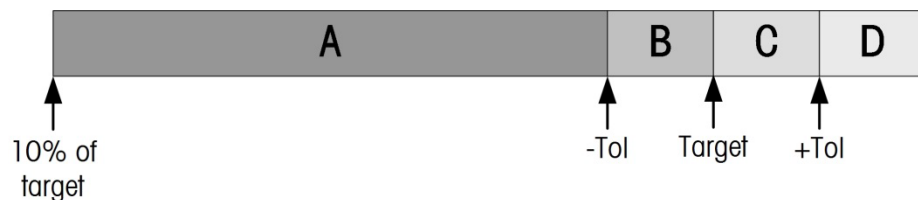

Figure 2-16: SmartTrac Bar Graph Display Ranges

2.6.12.1.1. Under Tolerance

The Under Tolerance range is labeled "A" in Figure 2-16. This range represents the amount of material from 10% of the target value to the target minus the negative tolerance value. The bar graph begins to populate the "A" range when more than 10% of the target has been added. Until reaching the 10% point, no fill is shown.

2.6.12.1.2. Acceptable Under Tolerance

Region B in Figure 2-16 represents the zone of acceptable tolerance below the target value.

2.6.12.1.3. On Target

When the measured value exactly equals the target value an unfilled triangle indication displays (see Figure 2-17).



Figure 2-17: On-Target Triangle

2.6.12.1.4. Acceptable Over Tolerance

Region C in Figure 2-16 represents the zone of acceptable tolerance above the target value.

2.6.12.1.5. Over Tolerance

Region D in Figure 2-16 represents the zone of unacceptable tolerance above the target value. In Region D, the fill rate reverts to the same rate as used in Region A. If the measured value is large enough that the number of dot columns required for display exceeds the number available, the display saturates and further increases in the measured value do not affect it.

2.6.12.2. Over/Under Mode

There are three sizes of Over/Under SmartTrac selectable in setup. Each size provides different target and weight information on the display. Figure 2-18 shows the small size, Figure 2-19 shows the medium size, and Figure 2-20 shows the large size. Note that Figure 2-18 shows a composite display with under, OK and over graphics displayed simultaneously.

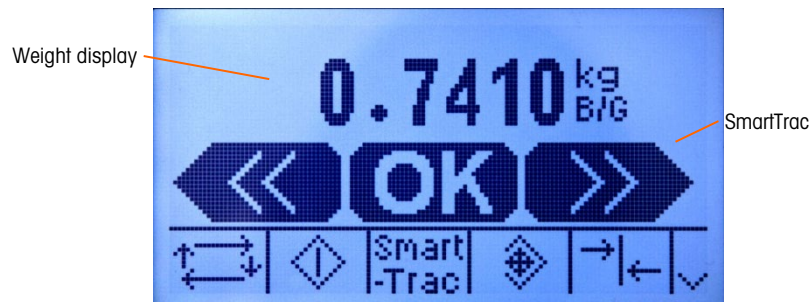

Figure 2-18: Over/Under Display, Small



Figure 2-19: Over/Under Display, Medium

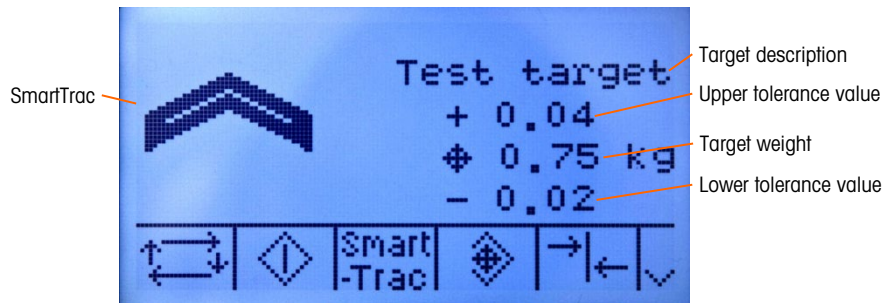



Figure 2-20: Over/Under Display, Large

2.6.12.2.1. Less than 10% of Target

Until the weight on the scale reaches 10% of the target value, the Under symbol is shown as a dashed line symbol  or , and the discrete outputs are disabled. The Under zone symbol becomes solid and the discrete outputs become active when more than 10% of the target has been added.

2.6.12.2.2. Under Zone

The Under zone is shown in Figure 2-18 as the symbol to the left and also in Figure 2-19. This zone classification is shown when the weight on the scale is greater than 10% of the target but less than the target value minus the -tolerance value. If a discrete output has been assigned to the Under Zone, that output will be "on" when the weight is in this zone.

2.6.12.2.3. OK Zone

When the weight on the scale is between the target minus the -tolerance and the target plus the +tolerance, the OK symbol is shown. This symbol is the same symbol for all sizes of SmartTrac and shown in Figure 2-18 as the center symbol. If a discrete output has been assigned as Tolerance - OK, that output will be "on" when the weight is in this zone.

2.6.12.2.4. Over Zone

The Over zone is shown in Figure 2-18 as the symbol to the right and also in Figure 2-20. This zone classification is shown when the weight on the scale is greater than the target value plus the +tolerance value. If a discrete output has been assigned to the Over Zone that output will be "on" when the weight is in this zone.

2.6.13. Time and Date

Time and date are used for reporting, error and transaction log timestamps, and triggering service events. The TIME & DATE softkey  enables access to the Set Time & Date screen where the user can set the time and date, including the hours, minutes, day, month, and year. When the time is set, seconds are set to 0.

Although the format for the time and date can be selected according to local preferences, the use of a timestamp in log files is not selectable. Timestamp formats are always fixed as:

Date: YYYY/MM/DD (for example, July 23, 2005 becomes the fixed format date 2005/07/23)

Time: HH:MM:SS stored in 24 hour format (for example, 10:01:22 PM becomes the fixed format time 22:01:22)

2.6.14. Reports

Reports may be generated, viewed, and printed from database tables including:

- Alibi Memory
- Tare Table
- Target Table

The REPORTS softkey  must display on the operational screens to generate table reports. Otherwise, table reports can only be generated from within setup.

To generate a report:

1. Press the REPORTS softkey . The Reports screen (Figure 2-21) displays.

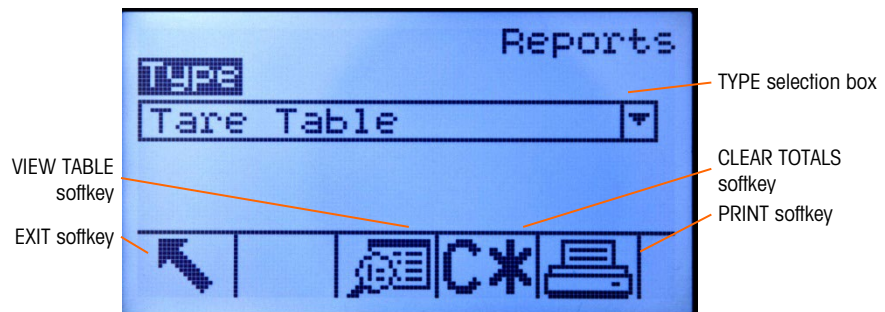





Figure 2-21: Reports Screen

2. Use the UP and DOWN navigation keys to select the desired type of database table report in the selection box.
3. The CLEAR TOTALS softkey **C*** displays when the Tare Table is selected that has totals enabled in setup. If Clear after Print is enabled in setup for the selected table, the CLEAR TOTALS softkey **C*** does not display. Press the CLEAR TOTALS softkey **C*** to clear the totals in the selected table. A warning displays that requires verification that the user wants to clear the table totals.
4. Press the PRINT softkey  on this screen to print the entire selected report.
5. The CLEAR TOTALS and PRINT functions are only accessible to users with a log-in level of Supervisor and above.
6. Press the EXIT softkey  to return to the home screen.
7. Press the VIEW TABLE softkey  to select a sub-set of records from the table. The Search Screen for the selected report type displays (see Figure 2-22).

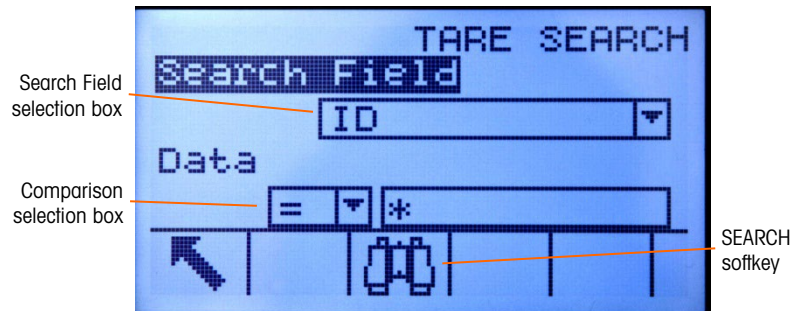

Figure 2-22: Search Screen (Tare Table)



8. Press the SEARCH softkey  to view all data in the table. Only fields enabled in setup display in tables.
9. To limit the data:
 - a. Use the Search Field selection box to select a desired search field (for example, search fields for the Tare table include Description, ID, n, Tare, and Total).
 - b. Use the Comparison selection box to select how the data will be limited (less than (<), less than or equal to (<=), equal to (=), greater than or equal to (>=), greater than (>), or not equal to (<>) are available in the selection box).
 - c. Use the numeric keypad to enter the limiting factor in the text box (the * character is the "wild-card" character and returns all results).
 - d. Press the SEARCH softkey  to view the limited data in the table. Search result records are always listed in order by ID (lowest to highest ID numbers). Use the arrow keys to scroll left and right to view additional columns. Figure 2-23 is an example of search results for a Tare Table, with a series of views showing all available columns of data.





Figure 2-23: Tare Table Search Results

2.6.15. Calibration Test

The IND560x terminal provides a programmable Calibration Test sequence that can contain up to 25 individual steps. The Calibration Test is designed to lead the tester through a set of predetermined steps and compare the terminal calibration with known test weights.

The test is accessed by pressing the CALIBRATION TEST softkey  ↓ on the home page. A screen displays where the name of the tester can be recorded and the serial number and capacity of each of the test weights used can be entered. This provides a traceable record for the calibration test.

The calibration test is started by pressing the START softkey . A display is shown that provides the active scale weight, the target and tolerance weight values, and two lines of instructions (as to where to place the weights). When the tester completes these instructions, he or she presses the OK softkey  and the terminal compares the actual weight on the scale to the programmed target weight for this step. If the comparison passes, the test continues to the next step. If it fails, a message displays that indicates a failure. After acknowledging the error, the tester can abort the test, retest this step, or skip this step knowing that it failed.

At the end of the complete test, a print can be initiated that prints all the data of the calibration test. A full description of the calibration test can be found in Chapter 3, Configuration, Maintenance, Configure/View, Calibration Test.

2.6.16. CalFree™

The IND560x terminal provides a method to calibrate a scale without using test weights. This is based on manual entry of capacity and performance data from the load cell or load cell platform. This method of calibration can be used for initial check-out and testing of systems or when a large structure is used as the weighing vessel and it is not possible to apply test weights to the structure. METTLER TOLEDO highly recommends that test weights be used whenever possible as this provides the most accurate method of calibration.



2.7. Alibi Memory Direct Access

The Alibi Memory stores transaction data that can be retrieved in order to verify transaction information.

- The information stored in the Alibi Memory includes:
- Transaction counter value
- Date and time of transaction



Gross, net, and tare weights including units of measure

2.7.1. To view and print the Alibi Memory



1. Press the Alibi softkey **Alibi** if programmed as one of the home position softkeys or press the REPORTS softkey  if programmed as one of the home position softkeys then select Alibi Memory from the selection box.
2. Press the VIEW TABLE softkey . The Alibi Search View screen displays.
3. Use the selection boxes and data entry fields to enter specific search information to limit the search, or do not enter any search limits to view all Alibi Memory Table information.
4. Press the START SEARCH softkey . The Alibi Search View screen displays the search results. Records are ordered by date and time with the most recent record shown last.

5. Press the PRINT softkey  on this screen to print the entire selected Alibi Memory Table.

2.8. Table Searches

A table search can be accessed using various methods, including the TARE MEMORY softkey , TARGET MEMORY softkey , ALIBI softkey **Alibi**, REPORTS softkey , and from the menu tree.

2.8.1. To search a table

1. Access the table to be viewed using the appropriate method.
2. Press the VIEW TABLE softkey . The Search View screen displays.
3. Use the selection and data entry boxes to enter specific search information to limit the search, or enter * (the “wild-card” character) to view all table information.
4. Press the START SEARCH softkey . The Search View screen displays with the search results.

2.9. Remote Display

When properly configured, the IND560x can function as a remote display for another Mettler Toledo terminal capable of handling Mettler Toledo Continuous Output.

If the Remote IND560x will be used to issue simple commands to another terminal (referred to as the Master terminal), the Master must also be able to accept Command Inputs (CPTZ).

- **IMPORTANT:** Proper barriers or approved METTLER TOLEDO communication modules are required for safe installation and transmission of signals. Please refer to the Installation Manual or METTLER TOLEDO control drawing 72191600 for specific instrument properties and equipment guidelines.

2.10. Automatic Reconnection to ACM500 Communication Module

The communication protocol between the IND560x and the ACM500 requires that the ACM500 be powered up first. If the ACM500 experiences a power cycle, the message shown in Figure 2-24 will display. In the past when this occurred, users were required to acknowledge this pop-up message by pressing the ENTER key. Users were then further required to manually power cycle the IND560x to re-establish communication between the terminal and the ACM500.

3 Configuration

This chapter provides information about how to configure the IND560x terminal's operating system. It describes access to the setup mode, where functions can be enabled, disabled, or defined by entering parameter values in specific setup screens.

3.1. Entering Setup Mode



The configuration of the IND560x terminal is accessed through the SETUP softkey . If password security has been enabled, a login screen (Figure 3-1) displays and the user must enter the correct password in order to advance into setup. (See the Security section in Chapter 2, Operation, and the Configuration Options, Terminal, Users section of this chapter for further information about password setup and security.) To exit back to the home screen without entering any login information, press the ESCAPE softkey .



Figure 3-1: Login Screen

3.1.1. To enter a username

1. Press the ENTER key to access the Username entry box. The softkeys change to alpha keys (see Figure 3-2).

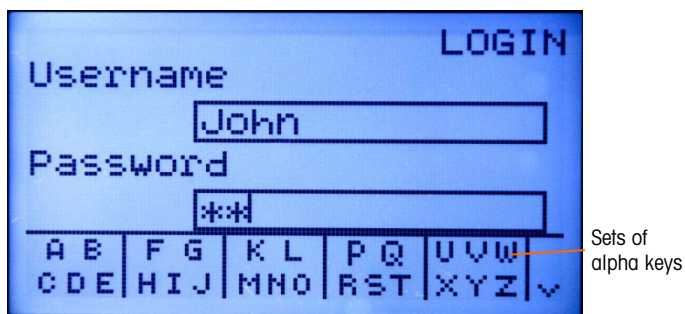



Figure 3-2: Login Screen (Alpha Keys)

2. Use the alpha keys to enter the username in the username entry box.

3. Press the ENTER key. The alpha keys no longer display.

3.1.2. To enter a password

4. With focus on the Password field label, press the ENTER key. The softkeys change to alpha keys (see Figure 3-2) and focus moves to the Password entry box.
5. Use the alpha keys to enter the password in the password entry box.
6. Press the OK softkey . If the username and password are correct, the terminal goes into setup mode. Once the terminal is in setup mode, the setup menu tree displays.

3.2. Exiting Setup Mode

To exit the setup mode, select Home from the setup menu tree and press ENTER. The default weighing operation screen displays.

- As an alternative, press the first softkey whenever the menu tree is displayed to exit the menu tree.

3.3. Setup Menu Tree

Each line of the setup menu tree is referred to as a branch (see Figure 3-3). Some branches have additional branches that become visible when the view of the main branch is expanded. If a branch has additional branches under it, the collapsed symbol (⊞) initially displays in front of the branch name. After the branch view has been expanded, the expanded symbol (≡) displays in front of the branch name and the additional branches become visible. Any branch that is not expandable is called a leaf node.

The first branch of the menu tree shown with focus is the Scale branch (Figure 3-3).

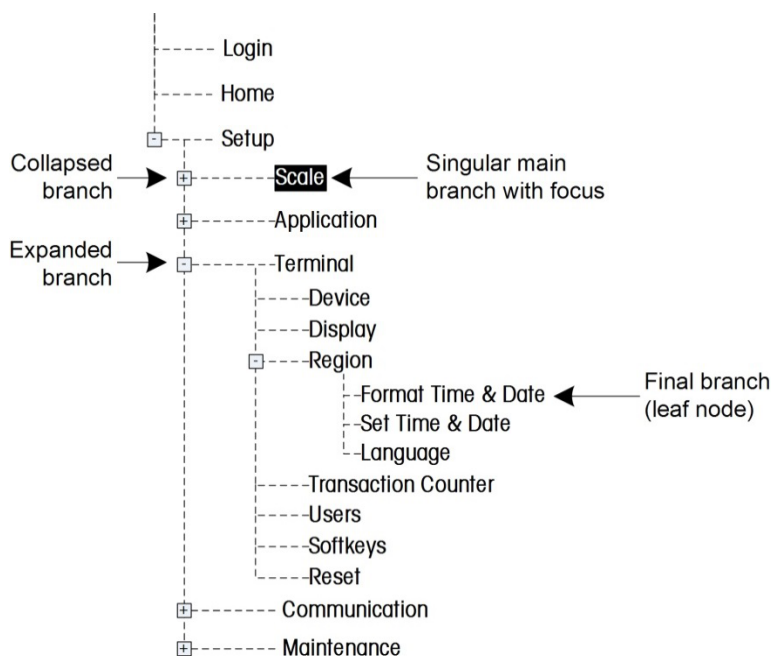

Figure 3-3: Setup Menu Tree Example

Use the UP and DOWN navigation keys to move focus through the branches of the setup menu tree.

Press the RIGHT navigation key to expand a branch and the LEFT navigation key to collapse a branch. When the focus is on a sub-branch, focus can quickly be moved back to the main branch by pressing the LEFT navigation key.

When a leaf node (singular, non-expandable) branch such as Device or Display is in focus, press the ENTER key to display the setup screen for that function.

3.3.1.1. Setup Screens

Setup screens enable access to data fields where parameters can be viewed, entered, or modified to configure the terminal to meet specific application function needs.

3.3.1.2. Navigation

Press the UP and DOWN navigation keys to move through the field labels displayed on each setup screen, and to move to a second or third setup screen when more than one screen is used for configuration fields associated with a specific parameter (indicated by the presence of a scroll bar). The shaded portion of the scroll bar (see Figure 3-4) indicates which screen is displayed.

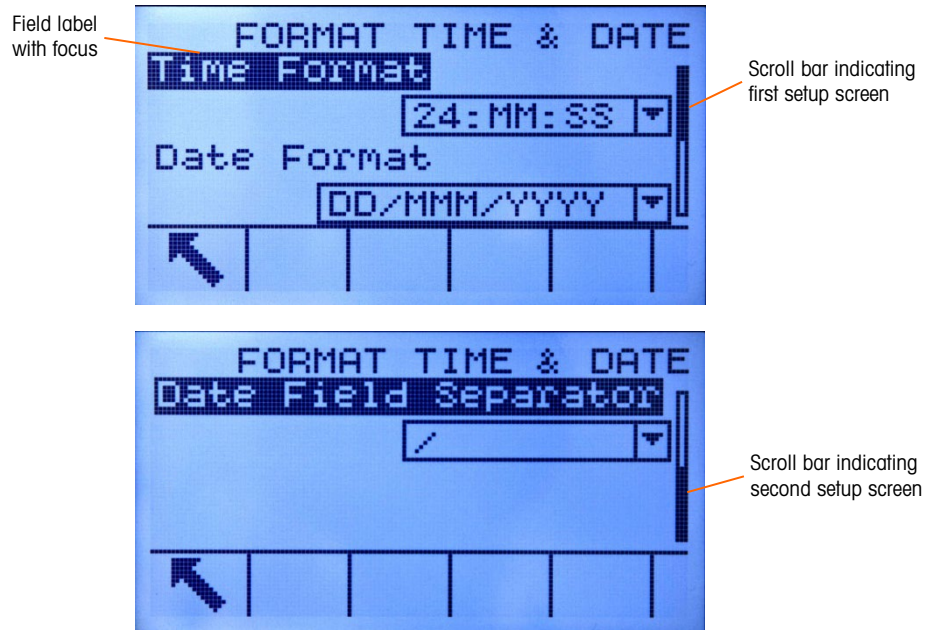

Figure 3-4: Examples of Setup Screens (Format Time & Date)

3.3.1.3. Data Entry

Press the ENTER key to move the focus from the field label to either the selection box or data entry box where data is to be entered or edited (see Figure 3-5).

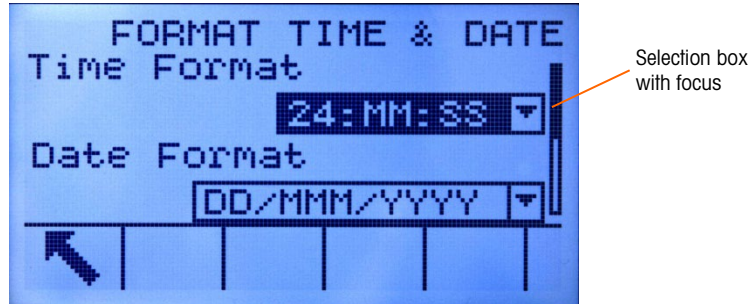

Figure 3-5: Setup Screen

If the field values are presented in a selection box, the current selection will have focus when the ENTER key is pressed.

To change the field value in a selection box:

1. Press the UP and DOWN navigation keys to scroll through the list and place the focus on the value to be selected.
2. Press the ENTER key to accept the selection as the value for the field. The selection displays as the value for the field and the focus moves to the next field label.

If the field value is for a data entry box and alpha/numeric character entry is possible, the alpha keys will display.

To change the field value using alpha/numeric characters:

1. When a data entry box is first entered, the previous data (if present) is in focus. To replace previous data, use the alpha keys and the numeric keypad to enter the desired value.

OR

2. Press the LEFT and RIGHT navigation keys to move the cursor into position if the value needs to be edited from a specific point rather than replaced. Position the cursor at the end of the data to be deleted and press the C key once for each character to be deleted.
3. Press the ENTER key to accept the entered alpha/numeric characters for the field. The entry displays as the value for the field and the focus moves to the next field label.
4. To exit a setup screen, press the EXIT softkey , which is in the first softkey position. The setup menu tree displays with the focus on the branch for the setup screen that was exited.

3.4. Overview of Configuration

The setup menu tree can be expanded to show every branch and leaf node in the terminal's configuration. Use the navigation keys to select the desired setup screen.

There are five major branches in the setup menu:

- Scale
- Application
- Terminal
- Communication
- Maintenance

Details for each branch are provided in the following Configuration Options section. Figure 3-6 shows the setup menu tree with all branches expanded.

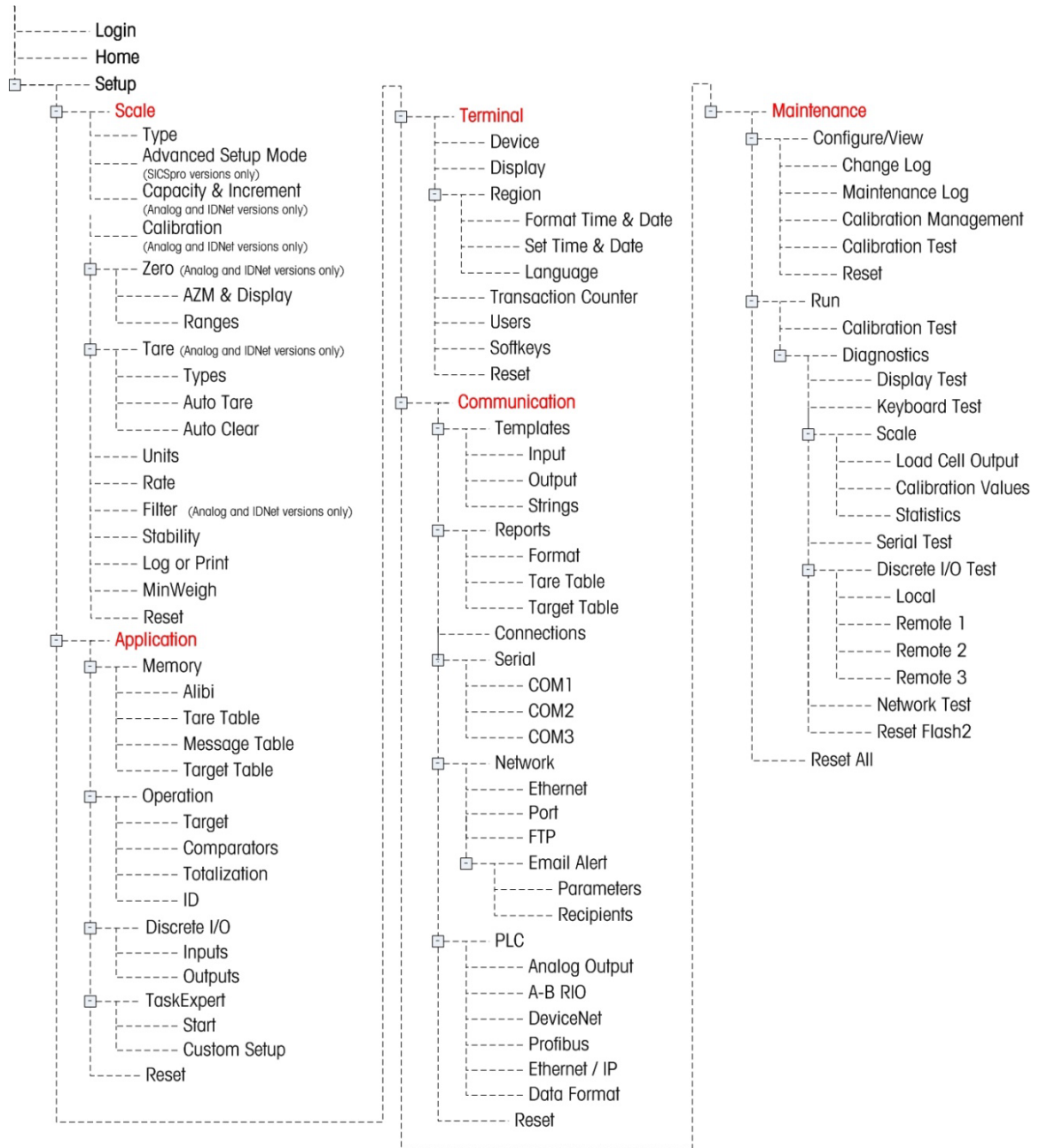

Figure 3-6: The IND560x Menu Tree with All Branches Expanded

- The TaskExpert leaf node is only available if the TaskExpert Application Software module has been installed into the IND560x.

3.4.1. Configuration Options

Configure terminal options on the setup screens that are available under the five major branches of the setup menu.

- If the metrology switch is in the approved position (SW1-1 = ON), access to the Scale branch is not permitted. The Scale branch will be expandable and viewable, but changes to setup will not be permitted. Access will be denied.

3.5. Scale

The Scale branch provides the following access to the configuration of the connected scales:

- Type*
- Advanced Setup Mode (SICSpro version only)
- Capacity and increment values*†
- Calibration*†
- Zero parameters*†
- Tare parameters*†
- Units
- Rate parameters
- Filter parameters*†
- Stability parameters*†
- Log or print threshold parameters
- Minimum weight parameters

- Leaf nodes that are marked with an asterisk (*) above will have different parameters depending on the connected scale type (analog, IDNet or SICSpro). Nodes marked with † appear within the Advanced Setup Mode (ASM) of the IND560x SICSpro terminal.

A Reset is present at the end of the branch to enable a limited reset to the factory default settings for the Scale branch parameters.

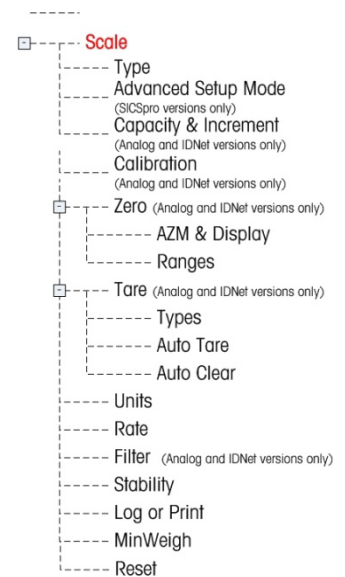

3.5.1. Type

The Scale Type screen permits a name to be assigned to the scale, displays the scale PCB Type in the terminal, provides a selection list for the Approval mode, and allows the IND560x to be configured as a Remote Display for another (Master) terminal. The EXIT softkey  will return the display to the menu tree.

3.5.1.1. Name

The Name field enables entry of the scale identification. Enter the scale name (an alpha-numeric string of up to 20 characters) in the Name entry box.

3.5.1.2. Scale Type

The Scale Type field automatically shows the hardware configuration. This field will display either Analog, IDNet or SICSpro, along with Remote. If Remote is selected, the approval option will not be available.

3.5.1.3. Load Cells

Load Cell parameters are shown only for IND560x analog main boards, and only if scale type selection is Analog. Load Cell parameters must be set correctly for analog IND560x terminals that will operate under battery power, because the current demand from the load cells determines the switch off voltage set point of the external battery.

Setting the Load Cell parameters correctly helps to ensure that all available capacity of the battery is used, and protects the battery pack from a deep discharge that will harm the NiMH cells and shorten the lifespan of the battery pack

Default values of the Load Cell parameters are 1 x 350 Ω . Enter the total number of analog load cells into the first field, and the impedance (resistance) of each individual load cell into the Ω (Ohm) field. If only the Total Scale Resistance is known, enter 1 as the number of load cells and the TSR into the Ω field.

If scale type is set as Remote, the number of cells is automatically set to 0.

3.5.1.4. Approval

Approval (analog load cells only) refers to the metrological (weights and measures) approval configuration for the specific scale. The Approval selection is not present for IDNet scale bases, but rather is part of the Service Mode of the base. For SICSpro, this parameter is displayed in the Metrology branch of the Advanced Setup Mode (ASM) on the terminal. This parameter displays the approval region of the system as programmed in ASM of the load cell. For analog load cells, the selection list can be set to:

- None – no approval is required
- USA
- OIML
- Canada
- Australia
- Argentina

If an approval (USA, OIML, Canada, or Australia) is configured and the metrology security switch, SW1-1, is set to ON, access to the Scale setup parameters in the menu tree will be limited to view only.

If the approval is configured as Argentina and the metrology security switch, SW1-1, is set to ON, access to the entire setup menu is prohibited. If an attempt is made to access the setup menu, an on-screen message will display stating "Access denied. Scale is Approved."

If an approval is selected but SW1-1 is not ON, it will not be possible to leave setup, and a message will appear: Switch UNSECURED.

3.5.2. Advanced Setup Mode (only in SICSpro version)

The Advanced Setup Mode provides access to program settings in the load cell. Refer to the manual of the SICSpro platform being connected for details of the setup steps included in ASM. Figure 3-7 provides an overview of the current ASM menu structure.

- The ASM menu can only display in English.

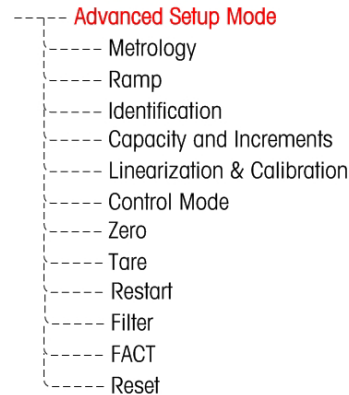

Figure 3-7: Advance Setup Mode Basic Menu Structure

3.5.2.1. Pairing Function

When a SICSpro base is connected via the pluggable, digital interface, and the system is in approved mode, the base-specific information is saved in the terminal to constitute a "paired" system to meet special legal requirements. The terminal uses the saved information to identify intentional or accidental manipulation of the approved system. The terminal checks pairing during each power up by reading the pairing parameters from the base and comparing with the parameters stored in the terminal. If Pairing fails, the terminal will display an "Approval Invalid" message in the system line every 5 seconds.

Pairing failure can occur if the wrong digital scale is connected to the terminal, or if the scale configuration was changed using another terminal, or if the terminal's configuration is reset.

3.5.3. Capacity and Increment

When IDNet scale bases are installed, the Capacity & Increment setup screen does not display. It is part of the Service Mode of the base.

For analog scales use the Capacity and Increment setup screen to select primary units, set the number of ranges or intervals, and the blanking over capacity.

- For SICSpro scales, the parameters described in sections □ and 3.5.3.2 are displayed in the Capacity and Increments branch of the Advanced Setup Mode (ASM) on the terminal. The parameter displays the capacity and increment of the system as programmed in the ASM of the load cell.

3.5.3.1. Primary Units

Set the primary units from the selection box choices, which include:

Grams (g)	Pounds (lb)	Tons (ton)
Kilograms (kg)	Tonnes (t)	

3.5.3.2. #Ranges

The number of ranges settings are available for analog load cells only. Set the number of ranges from one to three in the selection box. Specify the capacity and increment size for each range.

3.5.3.3. Blanking Over Capacity

The blanking over capacity settings are available for analog load cells only. Blanking of the display is used to indicate an over-capacity condition. Set the blank over capacity for the divisions (d) (display increments) that the terminal is permitted to go over capacity. For example, if capacity is set at 500 kg by 0.1 kg increments and the blank over capacity setting is 5 d, the terminal can display weights up to 500.5 kg. At weights over 500.5, dashed lines will display instead of a weight.

3.5.3.4. X10 Always

The X10 Always selection is available for IDNet load cells only. X10 Always locks the IDNet base into a higher resolution weight display. If the X10 Always mode is enabled, the high resolution weight data from the IDNet base displays at all times and the EXPAND BY 10 softkey **x10** (if configured to display) is inactivated.

Only the Primary Unit field displays and it is not selectable. The unit displayed is the unit in which the IDNet scale base was calibrated.

3.5.4. Calibration

The Calibration screen enables entry of a geo code adjustment value, the base serial number, calibration units, linearity adjustment, and analog gain jumper setting.

3.5.4.1. Geo Code

Enter the geo code for the appropriate geo adjustment value for the current geographical location. Geo codes are numbered 0–31.

The Geo Code field does not display when the IDNet scale base is used.

3.5.4.2. Base Serial Number

Enter the scale base serial number in this field. An entry of up to 14 characters is possible.

For SICSpro, the platform serial number is shown as entered in the Advanced Setup Mode (ASM) of the load cell in the information **i** screen.

3.5.4.3. Calibration Units

The Calibration Units setting is available for analog load cells only. Calibration units are listed in the selection box and are the same as the primary units selections, which include:

Grams (g) Tonnes (t)
Kilograms (kg) Tons (ton)
Pounds (lb)

3.5.4.4. Linearity Adjustment

The Linearity Adjustment setting is available for analog load cells only. Select the linearity adjustment from the selection box. Selections are as follows:

Disabled – Use only zero and one span point

3 point – Use zero, midpoint, and highpoint

4 point – Use zero, lowpoint, midpoint, and highpoint

5 point – Use zero, lowpoint, midpoint, mid-highpoint, and highpoint

3.5.4.5. Analog Gain Jumper



The Analog Gain Jumper Setting is available for analog load cells only. The analog gain jumper setting on the Main PCB can be either 2 mv/V or 3 mv/V. The terminal is shipped from the factory in the 3 mv/V setting. In order for the CalFree™ feature to operate properly, this parameter must indicate the position of the jumper on the Main board. The jumper settings are:

2 mv/V – Jumper installed on both pins



3 mv/V – Jumper removed

3.5.4.6. Calibration Softkeys

The Calibration setup screen displays softkeys that can be used for calibration procedures, including:

Capture Zero	
Capture Span	
Step Calibration	
CalFree	Cal FREE
Service Mode (IDNet scales)	Srvc Mode



3.5.4.6.1. Capture Zero

The Capture Zero function in the Calibration setup is available for analog load cells only. The CAPTURE ZERO softkey  triggers an independent operation to reset the zero condition of the scale. A status message displays when this softkey is pressed that directs the user to empty the scale and press the START softkey . The status of the capture zero operation displays. When the







operation is complete, a final status message displays that verifies the completion of the capture zero operation.

- If motion is present during the zero capture process, the terminal will average the weight readings then display an error message indicating unstable weight values were used. This message must be acknowledged to save the these values.

3.5.4.6.2. Capture Span

The Capture Span function in the Calibration setup is available for analog load cells only. The CAPTURE SPAN softkey || initiates a sequence to capture span that can be performed independently of capturing zero.







To capture span:

1. Press the CAPTURE SPAN softkey ||. The Capture Span setup screen displays.
2. Enter the weight for test load 1 and all other test loads if linearity has been enabled. Press the ENTER key.
3. Place test load weight 1 on the scale.
4. Press the START softkey . The status of the weight capture operation displays. When the operation is complete, a status message displays that verifies the completion of the weight capture.
- Press the ESCAPE softkey  to abort the calibration process and return the display to the previous screen.
5. After the first calibration step has completed, the menu will either display a prompt for the next calibration weight to be added (if 2, 3, or 4 test load steps are enabled by the linearity adjustment parameter) or will show a successful or failed calibration sequence.
- If motion is present during the span capture process, the terminal will average the weight readings then display an error message indicating unstable weight values were used. This message must be acknowledged to save the these values.
6. Repeat steps 3–4 for test loads 2, 3, and 4 if enabled by linearity adjustment.
7. If the capture span operation was successful, a verification message that reads “Capture Span OK” displays. If the capture span operation was not successful, an error message that reads “Calibration Failure” displays. If the calibration fails, repeat the capture span procedures. If the calibration continues to fail, contact a local METTLER TOLEDO representative for assistance.
8. Press the EXIT softkey  to return to the Calibration screen.

3.5.4.6.3. Step Calibration

The Step Calibration function in the Calibration setup is available for analog load cells only. The STEP CALIBRATION softkey  initiates a procedure that enables a “build-up” calibration for tanks and hoppers. For step calibration, the same amount of test weight is added for each step of the calibration procedure.

To perform a step calibration:



1. Press the STEP CALIBRATION softkey . The Step Calibration setup screen displays.
2. Enter the target weight for the test load (the same amount of test load weight is used in each step).
3. Press the START softkey . The Step Calibration screen displays. This screen shows an active (live) weight display (using the current span factor), the intended target weight as entered on the previous screen, and the next step for the operator "Add test weight."
4. Add test weight to the tank/hopper as prompted by the display. Each time test weight is added to the scale, the active display shows the weight.
5. When the full amount of test weight has been added, press the OK softkey . The test load is captured and span factors are saved. During the time the weight is captured and the new span factor is being calculated, the display "Add test weight" changes to "Capturing span." The display then changes to the next prompt "Remove test weight then fill to target."
6. Remove the test weight. The active display returns to zero.
7. Fill the tank/hopper with a substitute material up to the target weight.
8. Press the OK softkey . The target weight value recalculates to show the substitute material weight plus the initial intended target weight. The display changes to the next prompt "Add test weight."
9. Add test weight to the tank/hopper. The active display shows the weight.
10. Press the OK softkey . If the actual weight does not equal the target, a new span factor calculates and the display changes to "Capturing span." The active weight display changes to match the target weight value. The display changes to the next prompt "Remove test weight then fill to target."
11. Remove the test weight. The active display returns to the previous weight that displayed for the last test load.
12. Repeat steps 7 through 11 until an appropriate number of calibration steps have been completed for the specific application.
13. Press the EXIT softkey  at any step in the procedure to stop the step calibration process and return to the Calibration screen.

3.5.4.6.4. CalFree



The CalFree procedure is applicable for analog load cells only. The CALFREE softkey  provides access to the span calculation screen for precalibration of a scale without test weights. High-precision scale bases are precalibrated when received from the factory so this feature is not used.

To perform precalibration of span using CalFree:

1. Press the CALFREE softkey . The CalFree screen displays.
2. Enter the load cell capacity and rated load cell output values in the associated fields:
 - The total load cell capacity should be entered here. For example, for a tank with three 5000 kg cells, cell capacity would be 3 x 5000 kg or 15000 kg.
 - If multiple load cells are used, the average output of all cells should be entered here.

3. Enter an estimated preload value in the associated field. Estimated preload is an optional entry. During calculation, the terminal also tests for analog/digital (A/D) converter input saturation at full scale capacity. Estimated preload is included in this calculation if entered in this field. If the preload is unknown, leave this field blank.
 - This preload value is used only to determine overload conditions and is not used as a zero reference point. The zero reference point must be captured using the normal zero calibration procedure.
4. Press the OK softkey . The span is calculated using the parameters entered.
5. If the calibration operation was successful, a verification message that reads "Calibration OK" displays. If the calibration operation was not successful, an error message that reads "Calibration Failure" displays. If the precalibration fails, repeat the CalFree procedures. If the precalibration continues to fail, contact a local METTLER TOLEDO representative for assistance.
6. Press the ESCAPE softkey  to return to the Calibration screen.

3.5.4.6.5. Service Mode

Service Mode is available for IDNet load cells only. This screen displays a single box that shows messages from the IDNet base up to 16 characters. When either the  (Yes) or  (No) softkey is pressed, the terminal sends the respective response to the scale base and the next message to be displayed is transmitted back to the terminal from the base. This sequence remains constant during the complete service mode communication sequence. Refer to the service mode flow chart for the IDNet base used to view the exact sequence.

After the last communication from the scale base has been completed, the display returns to the Scale Type screen.

3.5.5. Analog Saturation Test

During the calibration process, the IND560x will determine if there is a potential for analog section saturation. The IND560x will compare the available number of counts with the captured span to confirm that the desired capacity is achievable. If the potential exists to saturate the analog section before system capacity is reached, the IND560x will display a warning message and recommendation that the system be recalibrated with a new, lower, capacity.

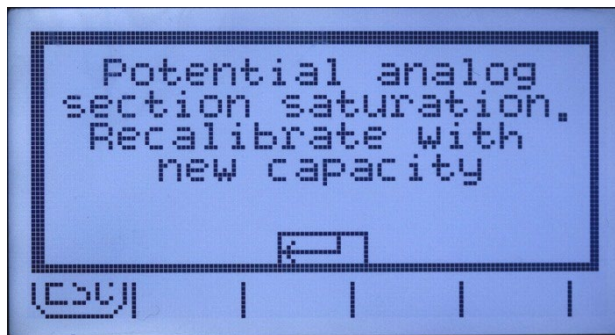

Figure 3-8: Analog Saturation Warning

This message functions only as a recommendation to recalibrate. After the warning message is acknowledged by pressing the ENTER key, the user is presented with the "Capture Span OK" screen and the BACK softkey. Service personnel should then carry out the following:

- Confirm that the analog gain jumper on the main board is set correctly for the actual load cell output, either 2mV/V or 3mV/V (refer to the Installation Manual, for jumper positions).
- If the analog gain jumper is correctly set, the scale should be recalibrated with a lower capacity. Potential analog section saturation does not force a failure in calibration.

IMPORTANT: It is critical that service personnel follow the recommendation to recalibrate or confirm that the analog output jumper is properly positioned on the main board. Analog section saturation will result in a 'freeze' of the display, where the display is no longer showing increases in weight, creating the possibility of overfills and spills during the weighing process.

3.5.6. Zero

This section provides access to Auto Zero Maintenance (AZM) settings, under zero blanking, power-up zero, and pushbutton zero parameters.

For SICSpro, this parameter is shown in the Advanced Setup Mode (ASM) branch of the terminal menu.

3.5.6.1. AZM & Display

AZM is a means of tracking zero when the scale is empty. AZM compensates for conditions such as terminal or load cell drift or debris on a scale platform.

3.5.6.1.1. Auto Zero

Use the AZM & Display setup screen to enable auto zero for gross weighing or gross and net weighing, or to turn auto zero off.

3.5.6.1.2. Auto Zero Range

Analog load cells: Set the auto zero range for the number of divisions (d) around the current zero setting in which auto zero will operate.

IDNet load cells: Either enable or disable the auto zero function.

MPXI (SICSpro) load cells: This parameter is shown in the Advanced Setup Mode (ASM) branch of the terminal menu.

3.5.6.1.3. Under Zero Blanking

The Under Zero Blanking function in the Zero setup is available for analog load cells only. Blanking of the display is used to indicate an under-zero condition when the weight on the scale falls below the current zero reference. Set the under zero blanking for the number of divisions (d) that the terminal is permitted to go under zero before blanking.

- A value of 99 disables blanking under zero and the terminal will display a weight as far under zero as possible.

3.5.6.1.4. Power Up

A Power Up setting of Restart enables the terminal to save and reuse the last zero reference weight after a power cycle so it returns to the same gross weight value. If reset is selected, the last zero

calibration value will be used as the zero reference point. Select either Reset or Restart from the Power Up selection box.

3.5.6.2. Ranges

Use the settings on the Ranges screen to enable or disable Power Up Zero and Pushbutton Zero and to set the ranges around the original zero condition for the scale for applying these functions.

3.5.6.2.1. Power Up Zero

The Power Up Zero function in the Zero setup is available for analog load cells only. If Power Up Zero is enabled, the terminal tries to capture zero upon power up.

3.5.6.2.2. Range

The Range setting for Power Up Zero is available for analog load cells only. If Power Up Zero is enabled, $-$ Range and $+$ Range fields will display for setting the range around the original zero condition for the scale within which Power Up Zero can be applied. The range units are percent.

For example, if the $+$ Range setting for Power Up Zero is set at 2%, Power Up Zero will only occur when the weight reading on the scale is at or below 2% of the original zero condition. If the $-$ Range setting for pushbutton zero is set at 2%, Power Up Zero will only occur when the weight reading on the scale is at or above $-$ 2% of the original zero condition.

- If Power Up Zero capture is enabled and the weight on the scale is outside of the zero capture range, the display will indicate EEE until the weight is removed and zero is captured.

3.5.6.2.3. Pushbutton Zero

If Pushbutton Zero is enabled, the front panel ZERO pushbutton will operate to capture zero reference points.

- If Pushbutton Zero is Disabled, execution of a remote Zero is still possible via SICS, CPTZ, or SMA commands, discrete inputs or from the PLC commands.

3.5.6.2.4. Range

The Range setting for Pushbutton Zero is available for analog load cells only. If Power If Pushbutton Zero is enabled, $-$ Range and $+$ Range fields will display for setting the range around the original zero condition for the scale within which Pushbutton Zero can be applied. The range units are percent.

For example, if the $+$ Range setting for Pushbutton Zero is set at 2%, the Pushbutton Zero can only be used when the weight reading on the scale is at or below 2% of the original zero condition. If the $-$ Range setting for Pushbutton Zero is set at 2%, the Pushbutton Zero can only be used when the weight reading on the scale is at or above $-$ 2% of the original zero condition.

3.5.7. Tare

Tare is used to subtract the weight of an empty container from the gross weight on the scale to determine the net weight of the contents. Tare is inhibited if the scale is in motion.

Three setup screens are available to configure tare:

Tare Types Auto Tare Auto Clear

For SICSpro, this parameter is shown in the Advanced Setup Mode (ASM) branch of the terminal menu.

3.5.7.1. Tare Types

Use the Tare Types setup screen to enable or disable pushbutton tare, keyboard tare, net sign correction, terminal tare (IDNet load cells only).

3.5.7.1.1. Pushbutton Tare

When pushbutton tare is enabled, the TARE scale function key $\rightarrow T \leftarrow$ can be pressed when an empty container is on the scale to determine tare. The terminal displays a zero weight and net mode. When the container is loaded and placed back on the scale, the terminal displays the net weight of the contents.

- If Pushbutton Tare is Disabled, execution of a remote Tare is still possible via SICS, CPTZ, or SMA commands, discrete inputs or from the PLC commands.

3.5.7.1.2. Keyboard Tare

When keyboard tare is enabled, the known value for the empty weight of a container (tare) can be entered manually. The terminal will then display the net weight of the contents of the container. Keyboard tares are automatically rounded to the closest display division.

3.5.7.1.3. Net Sign Correction

Net sign correction enables the IND560x terminal to be used for both shipping (inbound empty) and receiving (inbound loaded) operations. If net sign correction is enabled, the terminal will switch the gross and tare weight fields on the printed ticket, if necessary, so that the larger weight is the gross weight, the smaller weight is the tare weight, and the difference is always a positive net weight. Net sign correction affects the printed data output, the recalled weigh display and the displayed weight. Continuous data output will continue to show a negative net weight value.

Net sign correction will operate with pushbutton tare, preset tare, or tare memories. An example of weight values with and without net sign correction is shown in Table 3-1. In this example, the tare register value is 53 kg and the live weight on the scale is 16 kg.

Table 3-1: Weight Values With and Without Net Sign Correction

Printed and Displayed	Net Sign Correction	
	Disabled	Enabled
Gross	16 kg	53 kg
Tare	53 kg	16 kg
Net	-37 kg	37 kg

- When net sign correction is enabled, the tare weight field in the recall display will be labeled with the letter "M" to indicate "Memory" instead of "T" or "PT".

3.5.7.2. Terminal Tare

The Terminal Tare field only displays when an IDNet scale base is connected. Terminal Tare is disabled by default. When Terminal Tare is disabled, all Tare commands received by the IND560x

via SICS, CTPZ, PLC or keypad will be passed through to the IDNet base for execution. The base will calculate the tare and net weight values and pass this information back to the IND560x. When Terminal Tare is enabled, tare and net weight values are calculated in the terminal and not in the high precision IDNet base.

When Terminal Tare is enabled, the stability timeout value will be set to 3 seconds, but can be set to any value between 0 and 99 at Scale > Stability. A value of "99" instructs the terminal to wait indefinitely for a stable condition – a Tare command would never be aborted due to motion.

When Terminal Tare is disabled, the stability timeout value defaults to "99", and cannot be modified. The terminal will not display or transmit Net status, Net weight or Tare weight until it receives this information from the scale base. Only when the IDNet base responds will the terminal display and transmit the tare value and Net status to the PC/PLC.

Terminal Tare should be disabled for approved (legal-for-trade) systems.

3.5.7.3. Auto Tare

Use the Auto Tare screen to enable or disable automatic tare and to set the tare and reset threshold weights, and enable or disable motion check.

3.5.7.3.1. Auto Tare

When auto tare is enabled, the tare weight is taken automatically when a container above the threshold weight is on the scale and settles to no-motion.

3.5.7.3.2. Tare Threshold Wt.

When weight on the scale platform exceeds the tare threshold value and settles to no-motion, the terminal automatically tares.

3.5.7.3.3. Reset Threshold Weight

The reset threshold weight must be less than the tare threshold weight. When the weight on the scale platform falls below the reset threshold value, such as when a load has been removed, the terminal automatically resets the auto tare trigger, depending upon the programming of motion checking.

3.5.7.3.4. Motion Check

Enable the motion check setting to prevent auto tare reset trigger from occurring when the scale is in motion. When enabled, the scale must detect a non-motion condition below the reset value to reset the trigger.

3.5.7.4. Auto Clear

Use the Auto Clear screen to enable or disable auto clear tare, clear after print, to set the clear threshold weight, and enable or disable motion checking for auto clearing of tare.

3.5.7.4.1. Auto Clear Tare

To clear tare automatically when the scale returns to below the threshold weight, enable the auto clear tare setting.

- 3.5.7.4.2. Clear Threshold Wt.
When the gross scale weight exceeds then falls below the clear threshold weight value, the terminal automatically clears tare and returns to gross mode.
- 3.5.7.4.3. Motion Check
The Motion Check field displays only when Auto Clear Tare is enabled. Enable the motion check setting to prevent auto clear from occurring when the scale is in motion.
- 3.5.7.4.4. Clear After Print
The Clear After Print field displays only when Auto Clear Tare is enabled. To clear tare automatically after printing, enable the clear after print setting.
- 3.5.7.4.5. Clear With Zero
To clear tare automatically when capturing zero, enable the clear with zero setting.
- 3.5.7.4.6. Power Up
A Power Up setting of Restart enables the terminal to save and reuse the last tare weight after a power cycle. If Reset is selected, the terminal returns to gross mode upon power up and the last tare weight after the power cycle is cleared. Select either Restart or Reset from the Power Up selection box.

3.5.8. Units

This setup screen enables the selection of a second and a third unit and power up units.

- 3.5.8.1. Second Unit and Third Unit
Use the Second Unit and Third Unit selection boxes to select second and third weighing units, configure custom second and third units, or to select none. Only one custom unit is possible.

If printing of two units is required, establish Third Units. Both Primary and Third units can be printed simultaneously in an output template.

Available weighing units include:

Custom	Pounds-Ounces (lb-oz)
Pennyweight (dwt)	Ounces (oz)
Grams (g)	Troy Ounces (ozt)
Kilograms (kg)	Tonnes (t)
Pounds (lb)	Tons (ton)

- 3.5.8.2. Power Up
Power up units defines the units the terminal defaults to after power up. Use the selection box to select either Primary Units or Restart, which makes the power up units those that were active when power was removed.

3.5.8.3. Custom Units

If Custom is selected for second or third units, three additional fields display for configuring custom units. The terminal displays the first three letters of the custom name in the units area of the display when custom units are in use.

3.5.8.3.1. Custom Factor

Enter a multiplication factor for the custom unit in this field, such as 0.592 or 1.019. The primary unit is multiplied by the custom factor to obtain the custom value.

3.5.8.3.2. Custom Name

The softkeys turn into alpha keys when this field is selected. Use the alpha keys to enter the name for the custom unit. Up to 12 characters may be entered.

3.5.8.3.3. Custom Increment

Enter a custom increment in this field, such as 0.1 or 0.5. This step controls both the decimal position and the increment size of the custom unit value.

3.5.9. Rate

A Rate, expressed as change in primary or secondary weight units per time unit, may be programmed for display on the IND560x (Figure 3-9) and/or used in controlling discrete outputs – for example as the source for a Comparator (described later in this chapter).

- The Rate display is over-ridden by SmartTrac. If SmartTrac is enabled, the Rate display option is not available in the Terminal > Display screen.
- If the weight information in the terminal becomes invalid, the Rate display will show 0.000.

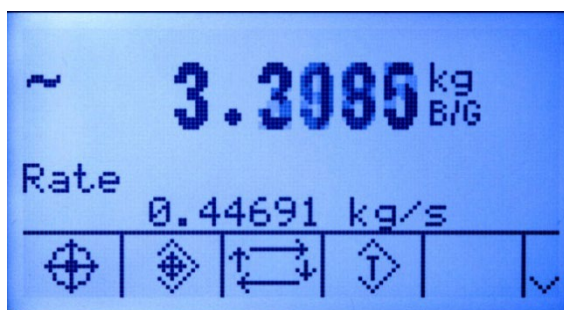

Figure 3-9: Rate Display on Home Screen

The following Rate parameters can be configured:

3.5.9.1.1. Weight Units

Weight Units may be set to None, Primary or Secondary. The Primary and Secondary selections correspond to the Units setting in the Scale > Capacity & Increment screen. Secondary units must be enabled at Scale > Units in order for secondary to be a unit selection for the Rate function. When the default value, None, is selected, the rate function is disabled. If the unit is a Custom Unit, a Custom Unit Name of up to 3 characters can be displayed.

3.5.9.1.2. Time Units

Time Units may be set to Seconds, Minutes or Hours. The default value is Seconds.

3.5.9.1.3. Measurement Period

The Measurement Period value sets the frequency of weight measurements. 1 second is the default value. Other options are 0.5 and 5 seconds.

3.5.9.1.4. Output Average

Output from the rate function is set by a computed rolling average of measurements. This possible range of values is 1 to 99 seconds, with a default value of 1. The Output Average value should be sufficiently larger than the Measurement Period to allow the terminal to take multiple measurements for each average.

3.5.10. Filter

The IND560x terminal has a low-pass, multi-pole vibration filter that can be set for several conditions when using analog load cells. The heavier the filtering, the slower the display settling time will be.

For SICSpro, this parameter is shown in the Advanced Setup Mode (ASM) branch of the terminal menu.

3.5.10.1. Low Pass Frequency

Low Pass Frequency configuration is available for analog load cells only. Low pass frequency is the frequency above which all disturbances are filtered out. The lower the frequency, the better the disturbance rejection, but the longer the settling time required for the scale.

3.5.10.2. Low Pass # of Poles

Low Pass # of Poles configuration is available for analog load cells only. The number of poles determines the slope of the filtering cutoff. For most applications, a slope value of 8 is acceptable; however, decreasing this number will improve settling time slightly.

3.5.10.3. Notch Filter Frequency

Notch Filter Frequency configuration is available for analog load cells only. The notch filter allows selection of one specific frequency below the low pass filter value that can also be filtered out. This enables setting the low pass filter higher to filter out all but one frequency (that the notch filter will handle) and obtain a faster settling time. Values from 0 (disable) to 99 are possible.

3.5.10.4. Stability Filter

Stability Filter configuration is available for analog load cells only. The stability filter works in conjunction with the standard low pass filter to provide a more stable final weight reading. The stability filter should only be used in transaction weighing applications, since the nonlinear action of the filter switching may cause inaccurate cutoffs in batching or filling applications. The stability filter can be enabled or disabled on this setup screen.

3.5.10.5. IDNet Filtering

Configuration for IDNet filtering parameters is performed on the Filter screen. Use the Vibration selection box to select a condition setting that reflects the specific location's conditions. Selections include:

Ideal Conditions	The weighing platform operates very quickly. However, it is very sensitive. This setting is suitable for a very calm and stable weighing location.
Average Conditions	This is the factory default setting and is suitable for most normal environments.
Extreme Conditions	The base reacts to changes in weight more slowly but is much more stable in unstable environments.

Use the Weighing Process selection box to select the specific weighing process in use. Selections include:

Fine Filling	Used when liquid or fine powders are being weighed
Universal Weighing	For solid materials coarse filling or checkweighing
Static Weighing	For solid materials and weighing under extreme conditions such as strong vibrations
Dynamic Weighing	For weighing products that will not be fully stable or still during the weighing process. Not intended for animal weighing.

3.5.11. Stability

The IND560x terminal includes a stability detector (weight in motion). For analog load cells, the Stability setup screen enables setting a motion range, no-motion interval and timeout period. For IDNet bases, a stability measure and timeout period may be set. For SICSpro bases, a timeout period may be set.

3.5.11.1. Analog Load Cell Stability

3.5.11.1.1. Motion Range

Sets the motion range to the weight value (in divisions) that the weight is permitted to fluctuate and still have a no-motion condition. Values from 0.1 to 99.9 are possible with the default value being 1.0.

3.5.11.1.2. No-motion Interval

The no motion interval defines the amount of time (seconds) that the scale weight must be within the motion range to have a no-motion condition. Values from 0.0 (motion detection disabled) to 2.0 are possible, the default value being 0.3 seconds. A shorter interval means that a no-motion condition is more likely, but may make weight measurement less precise.

3.5.11.2. IDNet Stability

3.5.11.2.1. Stability

Stability settings for IDNet load cells are configured by selecting a number setting of 0 (disabled), 1 (fast display, good repeatability), 2 (slow display, better repeatability), 3 (slower display, better repeatability), or 4 (very slow display, very good repeatability) in the Stability selection box.

3.5.11.3. SICSpro Stability

3.5.11.3.1. Timeout

Defines the period (in seconds) after which the terminal stops attempting to perform a function that requires a no-motion condition (such as a zero, tare or print command) and aborts the function. This timeout is used regardless of the source of the command such as the keypad, discrete input, PLC or SICS. Values from 0 to 99 are possible with the default value being 3 seconds. A smaller value means that less time will be used to check for no-motion before aborting a command. When a value of 0 is entered, there must be no-motion when a command is given or it will fail immediately. A value of 99 is a special condition which permits the terminal to wait indefinitely for a no-motion condition - a command would never be aborted.

3.5.11.4. Log or Print

The Log or Print setup branch is where the thresholds to control how and when data is saved or output to a printer are defined. Normal demand mode printing occurs whenever a print request is made, providing there is no motion on the scale and zero has been captured (a negative gross weight will not be printed).

The weight values entered are the gross weight values in primary units. Gross weight in primary units is used regardless of whether the IND560x is in Gross or Net mode and regardless of the units that are displayed.

3.5.11.4.1. Minimum Weight

The minimum weight setting is the threshold below which log or print functions will not initiate. Primary units are displayed for this field.

3.5.11.4.2. Interlock

Interlock prevents repeat logging and printing. If enabled, interlock requires that the weight reading be reset per the Reset on parameter setting (see below) and then settle to a weight greater than the minimum print value before responding to the next log or print request.

3.5.11.4.3. Automatic

Enable the automatic setting to log data and send a print request every time the weight on the scale settles to a positive value that is larger than the entered threshold weight value.

If Automatic is set to Disable, the Threshold Weight field does not appear.

3.5.11.4.4. Reset on

The resetting of auto printing or logging can be based on weight threshold or weight deviation values. Select Return (the weight must return to below this value to reset) or Deviation (the weight must change more than this value to reset) from the selection box and enter the weight value in the "Reset on" field.

If both Interlock and Automatic settings are disabled, the Reset on field does not display.

If Reset On is set to Deviation, The Threshold Weight and Motion Check fields do not display.

3.5.11.4.5. Threshold Weight

The Threshold Weight is the value above which an Automatic logging or printing of data can/will occur. Threshold Weight does not appear if Automatic is set to Disabled or if Reset On is set to Deviation.

3.5.11.4.6. Motion Check

Enable the motion check setting to prevent interlock and automatic log and print functions from resetting when the scale is in motion below the "Reset On" return point. Motion Check does not appear if Reset ON is set to Deviation.

3.5.12. MinWeigh

Enable the MinWeigh function to compare the current net weight with a MinWeigh value. If the net weight is greater than or equal to the MinWeigh value, all terminal functions behave normally. If the absolute value of the net weight is less than MinWeigh, the weight display includes a flashing MinWeigh symbol  to the left of the weight. If the user attempts to record the weight while in this condition, the printout will include an asterisk (*).

3.5.12.1. Entry Method

The MinWeigh value entry method can be either calculated by the IND560x or directly entered.

3.5.12.1.1. Calculated

MinWeigh is composed of 4 factors, each determined independently:

$$\text{MinWeigh} = \frac{U_0 \times \text{SF} \times 100\%}{T - (c \times \text{SF} \times 100\%)}$$

Where:

- U_0 = Uncertainty in measurement as the applied load approaches 0. U_0 is computed differently in each country and is entered in Primary units of measure.
- T = Tolerance in percent, which reflects the tolerances required for the specific process and facility. The range is 0.1%–99.9%.
- SF = Safety factor, which is another adjustment means. Usually $\text{SF} = 1$. The integer value range is 1–10.
- c = Uncertainty factor related to the portion of uncertainty in measurement that is proportional to the applied load. For reference only, $c = (U_{\text{MAX}} - U_0) / \text{Max}$, where Max = maximum weight and U_{MAX} = measurement uncertainty at maximum weight.

When Calculated is selected, the user is prompted to enter the uncertainty U_0 , c factor, tolerance percent, and safety factor in data entry boxes. The new MinWeigh value is then computed by the weighing equipment.

3.5.12.2. Direct

For direct entry of a MinWeigh value, user enters the desired value for MinWeigh directly in the MinWeigh data entry box. The MinWeigh value is entered in Primary units of measure.

3.5.13. Scale Type: Remote

When properly configured, the IND560x can function as a remote display for another IND560x terminal or for another Mettler Toledo terminal capable of handling Mettler Toledo Continuous Output. If the remote IND560x will be used to issue simple commands to another terminal (referred to as the Master terminal), the Master must be able to accept Command Inputs (CPTZ).

3.5.13.1. Physical Connection of Master and Remote Terminals

Communication for the remote display function occurs over a single serial connection. The configurable serial ports (COM1, COM2, COM3, COM4, COM5) in the IND560x can support one output and one input simultaneously, so only a single port is necessary for remote operation.

The standard COM1 port on the main board of the IND560x, COM4 and COM5 (on the optional fiber optic and current loop interface boards), and the optional COM2 and COM3 ports which would be installed in the ACM500, each support all three of the assignments used in the remote display function: Remote Display, Continuous Output and CTPZ Input. Communication can occur via RS-232, RS-422 or RS-485, but serial port parameters (baud, data bits, parity, flow control) must be the same for the Master and Remote terminals. Serial port configuration information can be found in Appendix D, Communications.

IMPORTANT: Direct connection of COM1 on the IND560x to another Mettler Toledo terminal will require the use of an appropriate signal barrier! Refer to the Installation Manual for details on barriers known to work with the IND560x.

3.5.13.2. Remote Terminal Communication via COM1

If the IND560x will function as the Remote terminal, and the communication will take place over COM1, the Scale > Type setting must be Remote, as shown in Figure 3-10. Note that the Approval option is not available in this configuration.

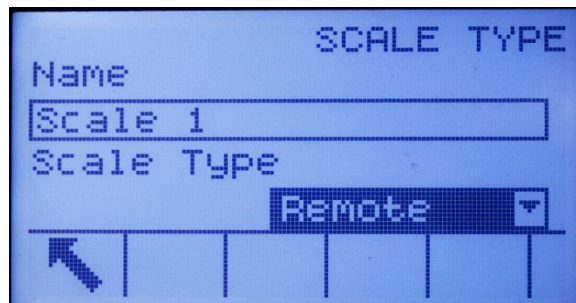

Figure 3-10: Scale Type Setting for Remote Operation

In addition, at Communication > Connections, the COM1 port must be assigned to Remote Display, as shown in Figure 3-11.



Figure 3-11: COM1 Connection Configured for Remote Operation

- **IMPORTANT:** An appropriate signal barrier is required when connecting a non-intrinsically safe device up to COM1 on the intrinsically safe IND560x.

3.5.13.3. Remote Terminal Communication via COM2 or COM3

If the IND560x will function as the Remote terminal and the communication will take place over COM2 or COM3 in the ACM500, the Scale > Type setting must be Remote, as shown in Figure 3-10. In addition, COM4 must be set as ACM500, as shown in Figure 3-12. Finally, COM2 or COM3 can be assigned as Remote Display as shown in Figure 3-13



Figure 3-12: COM4 Connection Configured for ACM500



Figure 3-13: COM2/COM3 Connection Configured for Remote Operation

3.5.13.4. Remote Terminal Communication via COM4 or COM5

If the IND560x will function as the Remote terminal and the communication will take place via a legacy fiber optic converter, another IND560x with fiber optic interface installed or the ACM500

(COM4 or COM5), the Scale > Type setting must be Remote, as shown in Figure 3-10. In addition, COM4 or COM5 must be set as Standard on the Connections setup page, as shown in Figure 3-14. Finally, COM4 or COM5 can then be assigned as Remote Display on the Connections View page as shown in Figure 3-15.

- NOTE: The IND560x cannot function as a remote display for another IND560x if the current loop interface is used. The current loop connection used in a remote display configuration requires one active and one passive end in the communication link, and only an active current loop interface is approved for use in the IND560x.



Figure 3-14: COM4 or COM5 Connection Configured for Fiber Optic Converter or ACM200



Figure 3-15: COM4 or COM5 Connection Configured for Remote Operation

3.5.13.5. Master Terminal Configuration

The Master terminal must have a port configured to send display information to the Remote terminal. At Communication > Connections the serial port assignment must be Continuous Output. If the Remote terminal will be used to send commands to the Master terminal, then the same port must have a second connection assignment for CTPZ Input.

Figure 3-16 shows a typical Remote Display setup, with the Master terminal able to receive commands sent from the Remote IND560x.

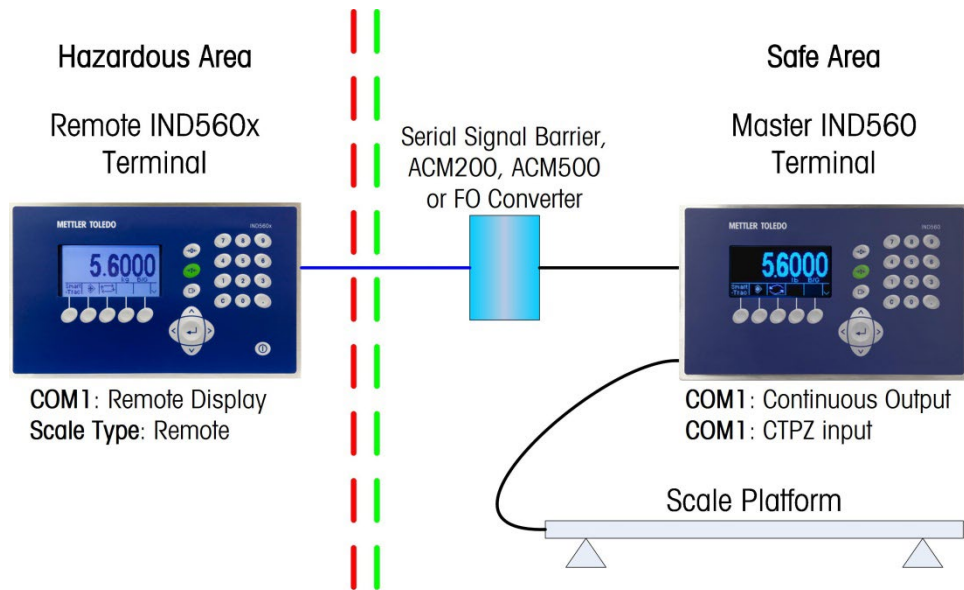



Figure 3-16: Example of Terminal Configuration for Remote Display Function

3.5.14. Reset

The Reset screen enables the Scale branch setup values to be reset to factory default settings.

3.5.14.1. Scale Reset

To initiate a reset, press the OK softkey . If the reset was successful, a verification message that reads "Reset Successful" displays. If the reset was not successful, an error message that reads "Reset Failure" displays. If the reset fails, try to initiate the reset again. If the reset continues to fail, contact a local METTLER TOLEDO representative for assistance.

Press the ESCAPE softkey  to exit without resetting.

- Scale reset does NOT include the reset of metrologically significant parameters – scale type, approval, weight units, capacity, increment, or calibration data. This data is reset only by performing a Master Reset with both switches 2-1 and 2-2 in their ON positions, or a Reset function in the IDNet or SICSpro load cell.

3.6. Application

Use application setup screens to configure:

- Memory and tables
- Operation of targets, totalization and the ID function
- Discrete I/O

3.6.1. Memory

Memory setup screens include:

- Alibi
- Tare Table
- Message Table
- Target Table

3.6.1.1.

Alibi

The Alibi Memory can be enabled or disabled in the selection box. Alibi memory is configured as a “ring” buffer that overwrites the oldest record when it reaches its memory limit. Alibi memory can hold approximately 60,000 transactions before it reaches its limit and begins overwriting old transactions. More detailed information about Alibi memory can be found in Chapter 2, Operation.

The Alibi Memory table stores basic transaction information that is not user-definable. This information always includes:

- Date and time stamp
- Transaction counter value
- Gross, tare, and net weights and weight unit
 - If the IND560x terminal has been programmed as “approved”, Alibi Memory enabling or disabling is only accessible if the security switch (SW1-1) is in the OFF position.

3.6.1.2.

Tare Table

The Tare Table displays stored tare records, including:

- Tare record ID
- Tare weight value and unit
- Description
- Total number of transactions using each stored tare record
- Total (accumulation of tare weights for each stored tare record)

More detailed information about the tare table memory can be found in Chapter 2, Operation.

Use the Tare Table setup screen to enable or disable description and to configure totalization.

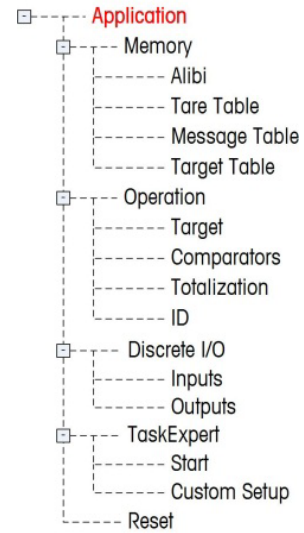

Description



Description is an alphanumeric string that describes the Tare Table entry. Use the Description selection box to enable or disable Description in the Tare Table structure.

Totalization









Totalization is a field that tracks the total weight for all transactions involving each tare in the table. Use the Totalization selection box to select None, Displayed Weight, or Gross Weight for totals in the Tare Table structure.

Press the CLEAR softkey  to reset the table. Log-in must be at supervisor level or above to reset the table.

To view Tare Table records:

1. Press the VIEW TABLE softkey . The Tare Search screen displays.
2. Use the selection boxes and associated fields to enter specific search information to limit the search, or enter * (the "find all" character) to view all Tare Table information.
3. Press the START SEARCH softkey . The Tare Search View screen displays with the search results. Only records with non-null tare values display. Records are ordered by ID, with the lowest ID number shown first.
4. Press the UP, DOWN, LEFT, and RIGHT navigation keys to scroll up and down and across the screen in order to view all data and all records listed.

To modify or add Tare Table records:



5. Press the UP and DOWN navigation keys to select (highlight) a record in the table.
6. Press the EDIT softkey  to open the setup screen for editing a record or press the INSERT softkey  to open the setup screen to create a new table record.
7. Press the UP and DOWN navigation keys to move the focus to the field name to be edited or inserted.
8. Press the ENTER key to select a field value to edit or insert. The alpha keys display.
9. Use the alpha keys and the numeric keypad to edit or enter the desired value.
10. Press the TARE softkey  to capture the current live scale weight and unit, which will display in the Tare field.
11. Press the OK softkey  to accept the modifications or additions to the Tare Table.
12. Press the ESCAPE softkey  to return to the Tare Search View screen without saving modifications or additions.
13. Press the DELETE softkey  to delete a tare record in the list.
14. Press the PRINT softkey  to print the list. Login must be at supervisor level or above to print the table.
15. Press the EXIT softkey  to return to the Tare Search Screen.

3.6.1.3. Message Table

The Message Table displays stored text messages and corresponding ID numbers that can be used to print templates. Only message records with non-null values display.

Press the CLEAR softkey  to clear the entire table. Login must be at supervisor level or above to clear the table.

To view Message Table records:

1. Use the selection boxes and associated fields to enter specific search information to limit the search, or do not enter any search limits to view all Message Table information.
2. Press the START SEARCH softkey . The Message Search View screen displays with the search results. Records are ordered by ID, with the lowest ID number shown first.
3. Press the UP and DOWN navigation keys to scroll up and down the screen in order to view all data and all records listed.
4. Modify or add Message Table information by editing, inserting, or deleting information as described previously under Tare Table.
5. Press the PRINT softkey  to print the list.
6. Press the EXIT softkey  to return to the Search Screen.

3.6.1.4. Target Table

Target comparison can be used in two types of applications: material transfer and over/under. Material transfer applications require that a control device deactivate when a target value is achieved. Over/Under applications classify a load placed on the scale platform as above or below the target value.

Values in the active record registers such as the target weight and tolerance, which can be manually modified or loaded from the Target Table, are compared with either the displayed or gross scale weight.

Use the Target Table setup screen to select the mode, tolerance type, and output type for use in target comparison.

More detailed information about the target table can be found in Chapter 2, Operation.

3.6.1.4.1. Mode

Use the Mode selection box to select the type of application for target comparison. Selections include:

- None
- Material Transfer
- Over/Under

3.6.1.4.2. Tolerance Type

Use the Tolerance Type selection box to select the type of tolerance to be used for target comparison. Positive tolerance and negative tolerance values can be entered as a deviation weight

value in the same units as the target (Target Deviation) or as a percent of the target value (% of Target).

When over/under mode is selected, a weight value choice is available as a tolerance type. In this mode, there is no target value used – only under limit and over limit values are used as zone edges for OK.



3.6.1.4.3. Output Type

The Output Type field is available only when the Material Transfer mode is selected. Use the Output Type selection box to select the type of two-speed output to be used in the target application. Selections include:

- Concurrent Both outputs operate at the same time
- Independent One output operates at a time (Fast Feed then Feed)

Press the CLEAR softkey **C** to reset the entire target table. Log-in must be at supervisor level or above to clear the table.

To view Target Table records:

1. Press the VIEW TABLE softkey  The Target Search screen displays.
2. Use the selection boxes and associated fields to enter specific search information to limit the search, or do not enter any search limits to view all Target Table records.
 - Search fields that display in the Search Field selection box vary depending on the selections made on the Target Table setup screen.
3. Press the START SEARCH softkey . The Target Search View screen displays with the search results. Only records with non-null values display. Records are ordered by ID, with the lowest ID number shown first.
4. Press the UP, DOWN, LEFT, and RIGHT navigation keys to scroll up and down and across the screen in order to view all data and all records listed.

Target Table records include different information, depending on the selections made on the Target Table setup screen. For example, Over Limit and Under Limit data displays only when the Over/Under mode is selected with Weight Value tolerance type.

Target Table records can include the following fields:

ID	Identification number for the active record
Description	Descriptive identification for the active record
Target	The desired measured value for a weighment
Target Units	The units of measure for the target weight (the target record units and the comparison units can be a combination of primary, second or third units)
Spill	The amount of material delivered after the control device is signaled to stop
Positive Tolerance	The highest acceptable tolerance above a target value

Negative
Tolerance

The lowest acceptable tolerance below a target value

Fine Feed Value

For two-speed applications, the fine feed value determines when the Fast Feed output turns off.

Modify or add Target Table information by editing, inserting, or deleting information as described previously under Tare Table.

Press the PRINT softkey  to print the list. Login must be at supervisor level or above to print the table.

Press the EXIT softkey  to return to the Search Screen.

3.6.2. Operation

Operation setup screens include:

- Target
- Comparators
- Totalization
- ID

3.6.2.1. Target

Use this setup screen to select which live measurement data stream (source) to use as input for target comparison and to enable or disable latching.

3.6.2.1.1. Source

Select which source to use as input for target comparison, either Displayed Weight or Gross Weight.

3.6.2.1.2. Motion Check

This parameter is shown only if target mode is set to Over/Under (at Application > Memory > Target Table). The default value is disabled. If Motion Check is enabled, the discrete outputs for Over, Under and OK are only activated when a no-motion condition is detected.

3.6.2.1.3. Latching





If the Target Table mode selection is Material Transfer, output latching can be selected. When output latching is enabled, the target comparison outputs remain latched (OFF) after the output switching threshold is exceeded until the latch is reset by a start input (softkey or discrete input).

If latching is disabled, the outputs will operate as coincidence-type outputs with no interlocks.



3.6.2.2. Comparators



The Comparators screen permits the configuration of simple targets controlled either by coincidence or by comparison with a range, and used as an assignment for Discrete I/O outputs. Comparators are controlled either by coincidence or by comparison with a target or range. The source for comparison can be the Gross Weight, Displayed Weight, Rate or assigned by a custom TaskExpert application.

3.6.2.2.1. Home Screen Comparators Softkey

The Comparator softkey | can be assigned to the weight display home screen. It opens the Comparators view screen, which displays the ID, Description, Limit, Unit, High Limit and Active values for each Comparator. An EDIT softkey  opens a screen that displays the selected Comparator's Description, and permits its Limit and High Limit values to be modified. Changes can be saved () or discarded () when returning to the Comparators view screen.

3.6.2.2.2. Comparators Configuration Screen

Source, Active, Description and Limit values can only be set from the Application > Operation > Comparators screen. This screen displays all five Comparators, and contains columns for ID, Description, Source, Limit, Unit, High Limit, and Active condition. From here, it is possible to EDIT  a Comparator, delete one , or clear  all Comparators.

Once parameters have been set in the Comparator Edit screen, they can be saved by pressing OK , or discarded by pressing ESCAPE . In either case, the view returns to the Comparators screen.

3.6.2.2.3. Source

The default value for Source is None, meaning that the comparator is disabled, and no other parameter fields are displayed. Other choices for the Source are Displayed Weight, Gross Weight, Rate and Application. If a weight field is selected as the Source, the weight unit will be primary units. If Rate is selected as the Source, then the unit will be the same as selected for Rate in the Scale > Rate branch. If Application is selected, no other parameter fields are displayed. This selection allows a TaskExpert custom application to control the source assignment for the Comparators.

3.6.2.2.4. Active

The Active setting determines the range of other options available in the Comparator Edit screen. These options are summarized in Table 3-2.

When Active is set to less than (<, the default value), less than or equal to (<=), equal to (=), greater than or equal to (>=), greater than (>), or not equal to (<>), the output is active depending on the relationship between the current Source value and the Limit. When Active is set to within (>_<) or outside (_<>_) a range, the source value is compared to the target value range set in the Limit and High Limit fields.

Table 3-2: Comparator Configuration

Source	None*, Displayed Weight, Gross Weight, Rate	
Active	<*, <=, =, >=, >, < >	>_ _< (within), _< >_ (outside)
Description	20 character alphanumeric string	
Limit	Target value	Lower target value for the comparison range
High Limit	n/a	Upper target value for the comparison range

3.6.2.2.5.

Description

The description is an alphanumeric string that is used to identify the type and purpose of the comparator. This string appears, together with the automatically assigned ID number (1-5), in the list that displays when the Comparator softkey is pressed.

3.6.2.2.6.

Limit

The Limit either sets the target weight value to which the actual source value is compared, or the lower target value for the range to which the currently measured source value is compared.

3.6.2.2.7.

High Limit

The High Limit is available only for Range mode, and sets the upper target value for the range to which the currently measured source value is compared. Its value must be higher than the Limit – if a lower value is entered, the terminal will show an Invalid Value message when the OK softkey  is pressed. The value is expressed in the programmed Rate unit.

3.6.2.3.

Totalization

Knowing how many weighing transactions were performed and how much material was processed during a particular period of time is useful information for many weighing applications.

The IND560x terminal provides both grand total (GT) and subtotal (ST) registers and counters. Counters have a limit of 1,500,000 and registers will accumulate up to 11 digits of weight including any decimal places to the right of the decimal point. For example, a scale programmed for 500 x 0.1 kg will accumulate weight values up to 9999999999.9 (11 total digits). If either of these limits is exceeded, an error message will display and the totals must be reset before additional weights or counts will be added.

Use the Totalization setup screen to select parameters for totalization operations, including which source to use as input for totalization, settings for grand totals and subtotals, and to enable or disable the conversion of second or third unit weights for totalization.

3.6.2.3.1.

Mode

Select which source to use as input for totalization comparison – either Displayed Weight or Gross Weight. A selection of None disables totalization.

3.6.2.3.2. Clear GT on Print

GT can be configured to clear automatically after printing the Totals report. If Clear GT on Print is enabled, the subtotal also clears automatically after printing the Totals report.

3.6.2.3.3. Subtotal

ST can be separately disabled while GT continues to accumulate weights. Choose to either enable or disable the subtotal register.

3.6.2.3.4. Clear ST on Print

Clearing the subtotal on print and not clearing the grand total on print allows the subtotal register to totalize sub-sets of weighments and to be reset while the grand total continues to track the grand total of weight. Choose to Clear ST on Print or not by selecting enabled or disabled in the selection box.

3.6.2.3.5. Convert Weight

The total registers always store weights in primary units. If Convert Weight is disabled, scale weights other than primary units are not accumulated. If Convert Weight is enabled, then the weight is converted to primary units, then accumulated.

3.6.2.4. ID

The ID function is a simple but powerful means of facilitating specific data input from the operator or causing a specific action to take place. The prompt list may include up to 20 steps, each step containing a command that determines the action the IND560x terminal will take when the step is executed.

The sequence can be programmed to run once (for example, when initiated by the pressing the ID softkey **ID**) or to loop continuously until terminated. It can also be initiated and restarted automatically, triggered by weight input from the scale. In either case, the operator works through a prompted series of actions or data entries. For example, the operator could place a package on the scale, be prompted to enter his or her name, enter a pre-set tare value, scan a bar code on the package, and generate an automatic print before finally removing the package from the scale. The printed data could include the net weight value, together with the scanned package information and the operator's name. The content and format of the printed information is determined by the template assigned to the demand output.

3.6.2.4.1. ID Mode – None

If None is selected as the ID Mode, then the ID function is disabled.

3.6.2.4.2. ID Mode – Automatic









Automatic Mode triggers the ID sequence when a weight above the Threshold weight value is placed on the scale and a no-motion state is detected. The sequence trigger rearms again after the weight falls below the Reset weight value. Press the EXIT softkey  to exit the sequence.

3.6.2.4.3. ID Mode – Softkey



In this mode, the ID softkey **ID** triggers the sequence, which either runs once (if Looping is Disabled) or continuously (if Looping is Enabled). In either case, pressing the EXIt softkey  exits the sequence.

3.6.2.4.4. Configuring ID Sequence Steps

Once the Mode Parameters have been set, ID sequence steps can be viewed, created, edited or deleted by pressing the VIEW TABLE softkey .

1. The ID Search screen displays, permitting the search results to be filtered by #, Type, Length or Prompt.
2. Either select a field to search and enter a comparative operator (<, <=, =, >=, >, <>) and alphanumeric information in the Data fields; or leave the wildcard asterisk (*) in the Data field to view all existing steps.
3. Press the START SEARCH softkey  to display the ID View screen. From here, ID steps can be edited , created , erased  and printed .
4. The # value is automatically assigned. It determines the order in which the steps will execute. Steps may be inserted into an existing sequence by selecting an entry and pressing the NEW softkey  to define a new step. The newly created step will appear in the sequence before the selected entry, and all subsequent # values will increase by one. To move a step in the sequence, it must be deleted and re-entered in the appropriate position.
5. The ID Edit screen is accessed by pressing the NEW softkey  or the EDIT softkey . The parameters that can be set for each step depend on the Type of step selected are shown below:

Type	Parameters	Options
Alphanumeric Numeric	Prompt	Enter up to 20 characters as the text or prompt for the step to display on-screen during the ID sequence.
	Length	Enter numeric value (0 - 40) to constrain the length of the response input after the prompt. If length of 0 is entered, the prompt is shown without an entry field. The step is then displayed as an instruction in the sequence. In this case, ENTER must be pressed to move to the next step. During entry, once the length value is met, the terminal will not accept further input; incorrect entries can be deleted using the CLEAR key.
	Clear Data	Disabled, Enabled. Permits the entered response (e.g., Operator's name) to be retained from one cycle to the next. If disabled, the next time the field displays it contains the data entered during the previous cycle, and pressing ENTER accepts the value and moves to the next step. If enabled, the entry field will be blank when viewed the next time.
Clear Tare Print Tare – Auto	None	
Tare – Preset	Prompt	See Prompt, above
	Length	See Length, above
	Clear Data	See Clear Data, above

6. As many as 20 steps can be created. They can be printed at any point using the PRINT softkey . Return to the setup menu tree by pressing the EXIT softkey  three times.

3.6.3. Discrete I/O

Discrete I/O setup screens include:

- Inputs
- Outputs



3.6.3.1. Inputs

The Discrete Inputs screen displays discrete input assignments, including the input assignment address, polarity, and function. Only records with non-null values display.

To clear the entire table, press the CLEAR softkey , then press OK  to confirm the action. Login must be at supervisor level or above to clear the table.

Press the UP and DOWN navigation keys to scroll up and down the screen in order to view all of the possible discrete input assignments.

To modify or add discrete inputs:

1. Press the UP and DOWN navigation keys to select (highlight) a discrete input.
2. Press the EDIT softkey  to open the setup screen for editing an input assignment or press the INSERT softkey  to open the setup screen to create a new input assignment.
3. Enter the input assignment address. The input address is shown as [x.y.z] where x indicates the input location, y indicates the slot address of the I/O option, and z indicates the input position. The input address digits are:

Location – The first digit represents whether the I/O is local (0) or remote (1–3).

Slot Address – The second digit will always be a 1 for the IND560x internal I/O and a 0 for the remote I/O (ARM 100).

Position – The third digit refers to the position (1–4) of the discrete input option (internal or remote) that is being assigned to a function.

Valid address numbers are:

Local – 0.1.1, 0.1.2, 0.1.3, 0.1.4

Remote #1 – 1.0.1, 1.0.2, 1.0.3, 1.0.4,

Remote #2 – 2.0.1, 2.0.2, 2.0.3, 2.0.4,

Remote #3 – 3.0.1, 3.0.2, 3.0.3, 3.0.4



Examples:

Address 0.1.1 = Local discrete board , position 1 .

Address 1.0.3 = Remote address #1, position 3.

4. The inputs can be programmed to accept either a + True or – True polarity level as “ON”. Use the Polarity selection box to select + True or – True.
5. Use the Assignment selection box to select an input assignment. Selections are:

• None	• Disable Setup	• Target Pause/Abort	• Unit Switching
• Blank Display*	• Enter	• Target Start/Resume	• Unit - primary
• Calibration Test	• Print	• Trigger 1	• Unit - second
• Clear Tare	• SmartTrac	• Trigger 2	• Unit - third
• Disable Keypad*	• Tare	• Trigger 3	• Zero

* Blank Display and Disable Keypad are designed to be continuously and semi-continuously activated by a simple press-and-hold or key and lock mechanism
6. Press the OK softkey  to accept the entry.
7. Press the ESCAPE softkey  to return to the Discrete Inputs screen.
8. Press the DELETE softkey  to delete an input assignment.

3.6.3.2.

Outputs

	 WARNING
	IN APPLICATIONS WHERE THE PLC CONTROLS THE DISCRETE OUTPUTS REMOTELY, LOSS OF PLC COMMUNICATION WILL NOT RETURN CONTROL OF DISCRETE OUTPUT/S TO THE TERMINAL.

The Discrete Outputs screen displays discrete output assignments, including the output assignment address and function. Only records with non-null values display.

To clear the entire table, press the CLEAR softkey **C**, then press OK  to confirm the action. Login must be at supervisor level or above to clear the table.

Press the UP and DOWN navigation keys to scroll up and down the screen in order to view all of the possible discrete output assignments.

To modify, add, or delete discrete outputs, follow the same procedures described for inputs. Valid address numbers are:

Local – 0.1.1, 0.1.2, 0.1.3, 0.1.4, 0.1.5, 0.1.6

Remote #1 – 1.0.1, 1.0.2, 1.0.3, 1.0.4, 1.0.5, 1.0.6

Remote #2 – 2.0.1, 2.0.2, 2.0.3, 2.0.4, 2.0.2, 2.0.6

Remote #3 – 3.0.1, 3.0.2, 3.0.3, 3.0.4, 3.0.5, 3.0.6

Examples:

Address 0.1.1 = Local discrete board , position 1.

Address 1.0.3 = Remote address #1, position 3.

The selections for output assignments are:

- | | | | |
|------------------|----------------|-----------------|------------------|
| • None | • Comparator 3 | • Feed | • Over Zone |
| • Center of Zero | • Comparator 4 | • Motion | • Tolerance - OK |
| • Comparator 1 | • Comparator 5 | • Net | • Under Zero |
| • Comparator 2 | • Fast Feed | • Over Capacity | • Under Zone |

3.6.4. TaskExpert

The TaskExpert screens allow you to set up a TaskExpert program, and to access custom setup screens defined by your TaskExpert application.





- Note that TaskExpert setup screens are not accessible unless the TaskExpert option is enabled in the terminal. TaskExpert is enabled in the terminal by installing the TaskExpert Application Software key (iButton).

3.6.4.1. Start

The TaskExpert Start screen allows you to list your TaskExpert programs and associate each of them to a Task number. Each task can be set to run automatically on startup or after leaving Setup, or started manually using the Task List , or the Task 1, Task 2 or Task 3 softkeys.

Press the CLEAR softkey **C** to reset the table.

To modify the TaskExpert Start list:

1. Use the arrow keys to select the task to be edited or deleted. With the record selected:
2. Press the EDIT softkey  to modify a record. Note that the Task number cannot be modified.
3. Press the DELETE softkey  to delete a record.
2. To create a new task press the NEW softkey . A TASK EXPERT EDIT screen will display.
3. The Task number will be assigned automatically. Enter the name of the TaskExpert file in the File Name field.
4. Set Auto Start to Enabled or Disabled. If Enabled is selected, the task will run each time the indicator is powered up or when Setup is exited.
5. Set Manual Start to Enabled or Disabled. This will cause the program to run when selected and started.
6. Press  to save changes or  to exit without saving.

3.6.4.2. Custom Setup

The Custom Setup menu is defined by the TaskExpert application. For details, refer to the TaskExpert Reference Manual, provided with TaskExpert.

3.6.5. Reset

The Reset setup screen resets setup values to factory default settings for the Application branch setup. Login must be at supervisor level or above to perform a reset.

3.6.5.1.1. Application Reset

To initiate a reset, press the OK softkey . If the reset was successful, a verification message that reads "Reset Successful" displays. If the reset was not successful, an error message that reads "Reset Failure" displays. If the reset fails, try to initiate the reset again. If the reset continues to fail, contact a local METTLER TOLEDO representative for assistance.

Press the ESCAPE softkey  to exit without resetting.

- Application reset does NOT include the reset of information in Alibi Memory or tables. This data can only be reset by selecting Maintenance, Reset All.

3.7. Terminal

Setup screens for Terminal setup include:

- Device*
- Display*
- Region
- Transaction counter
- Users
- Softkeys

■ Leaf nodes that are marked with an asterisk (*) above will have different parameters depending on the connected scale type (analog or IDNet).

Use these setup screens to configure:

- External battery compatibility and power saving options
- Trax EMT™ ID fields
- SmartTrac display settings
- Time and date format and settings
- Language
- Transaction counter settings
- Users
- Softkeys

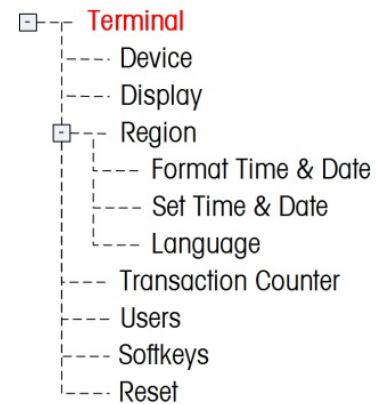

3.7.1. Device

Use the Device setup screens to enable harsh/analog terminal compatibility with the external NiMH battery pack and to enter data for the three terminal IDs and terminal serial number.

3.7.1.1. Battery Operation

This parameter is only shown in IND560x models with analog main boards. The default value is Disabled. Setting this parameter to Enabled will cause the IND560x to use the Load Cell parameters established at Scale > Type. Enabling Battery Operation also unlocks an Auto Power Off parameter at Terminal > Device.> Display.

3.7.1.2. Terminal ID

Up to three terminal IDs can be entered on the Device setup screen. When the Terminal ID text box is selected, the softkeys become alpha keys. Use the alpha keys to enter up to three terminal IDs. Press the ENTER key to accept the ID entered. These ID fields display in the information recall when the SYSTEM INFORMATION softkey **i** is pressed after the RECALL softkey **?**.

3.7.1.3. Serial Number

When the Serial Number text box is selected, the softkeys become alpha keys. Use the alpha keys to enter the terminal's serial number. The serial number is located on the back of the terminal. Press the ENTER key to accept the serial number entered.

3.7.2. Display

Use the Display setup screen to set the screensaver timeout and the SmartTrac™ size settings.

3.7.2.1. Screensaver

Enter the number of minutes (up to two digits) that must elapse with no scale motion and no keypad activity before the screensaver is shown (replaces the view on the display screen). If motion is detected or any key is pressed, the screen saver automatically exits and its time is reset. A keystroke used to exit the screen saver mode is ignored for all other purposes.

A setting of 0 in the Screensaver field will disable the screensaver.

3.7.2.2. Backlight

The IND560x is equipped with a backlight for improved viewing in some conditions. The backlight can be enabled or disabled. If the backlight is enabled, an additional selection for Backlight Timeout appears.

3.7.2.3. Backlight Timeout

Allowable values for Backlight Timeout are 0 (always on) to 99 minutes. The default setting is 10 minutes.

3.7.2.4. Auto Off Timer

If the Battery Operation parameter at Terminal > Device has been Enabled, users can choose to activate an auto-power off feature that will help to optimize single charge battery life. The Auto Off Timer parameter monitors scale motion and keypad operation. If no keypad activity occurs within the selected time value, the terminal automatically turns itself off. This auto-shutdown will occur with no warning to the operator.

Choices are:

- Disabled (default)
- 10 minutes
- 30 minutes
- 60 minutes

3.7.2.5. SmartTrac Size

SmartTrac refers to a graphical display visualization used to represent measured values. The display is either a bar graph (if material transfer is selected as the target mode) or an over/under display (if over/under is selected as the target mode).

The graphical display varies in terms of the amount of data displayed. While the SmartTrac graphic remains constant in size, the "small" setting includes minimal information, while the "large" setting displays the description as well as the target and limit values.

Examples of different sizes of SmartTrac displays are as follows:



	Material Transfer Mode	Over/Under Mode
Small		
Medium		
Large		

Figure 3-17: SmartTrac Display Sizes, Material Transfer and Over/Under Modes

Use the SmartTrac Size selection box to select a setting for the SmartTrac graphical display. Selections include None, Large, Medium, and Small.

- If this parameter is set to None, SmartTrac will not display when the SmartTrac softkey is pressed at the home screen. Instead, a message will display: "This Function is disabled."

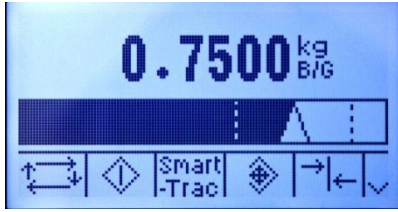
3.7.2.6. Rate Display

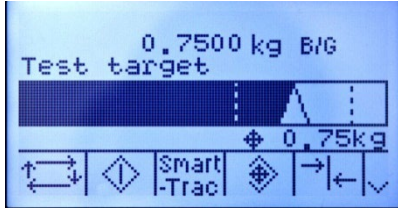
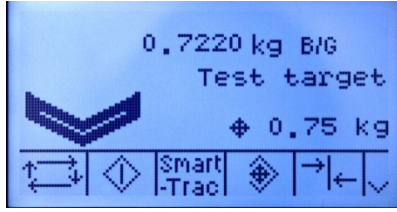
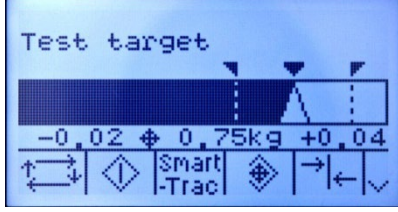
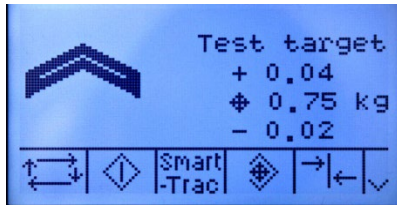
If a Rate is configured at Scale > Rate, it may be displayed on the home screen or not, depending on whether this value is set to Enabled or Disabled. The option to display Rate does not appear when SmartTrac is set to any value other than None.

3.7.3. Region

The region setup screens enable configuration of:

- Time and date format
- Time and date settings
- Language

3.7.3.1. Format Time & Date

Selection boxes on this setup screen enable formatting of:

3.7.3.1.1. Time Format

12:MM (12-hour clock with hour and minutes displayed)

12:MM:SS (12-hour clock with hour, minutes, and seconds displayed)

24:MM (24-hour clock with hour and minutes displayed)

24:MM:SS (24-hour clock with hour, minutes, and seconds displayed)

3.7.3.1.2. Date Format

DD MM YY (Two-digit day, month, year)

DD MMM YYYY (Two-digit day, three-character month, four-digit year)

MM DD YY (Two-digit month, day, year)

MMM DD YYYY (Three-character month, two-digit day, four-digit year)

YY MM DD (Two-digit year, month, day)

YYYY MMM DD (Four-digit year, three-character month, two-digit day)

3.7.3.1.3. Date Field Separator

/ (slash)

- (dash)

. (period)

(space)

None

3.7.3.2. Set Time & Date

Enter the hour, minutes, day, month, and year on this setup screen's text fields and selection boxes. The terminal automatically adjusts the date for a leap year, and a battery backup maintains the time and date settings in the event of a power outage.

- Manual setting of the time is necessary for daylight savings time adjustments.

3.7.3.2.1. Hour

Use the numeric keypad to enter the hour in the Hour field text box. Use the AM/PM selection box to select AM or PM. The AM/PM selection box only displays if the time format is set to 12:MM or 12:MM:SS on the Format Time & Date setup.

3.7.3.2.2. Minutes

Use the numeric keypad to enter the minutes in the Minutes field text box.

3.7.3.2.3. Day

Use the numeric keypad to enter the day in the Day field text box.

3.7.3.2.4. Month

Use the Month selection box to select the month.

3.7.3.2.5. Year

Use the numeric keypad to enter the year in the Year field text box.

3.7.3.3. Language

Use the Language setup screen to specify the language for terminal operations.

3.7.3.3.1. Display Messages

Use the Display Messages selection box to select the language for messages that display on the terminal. Choices are:

- English
- French
- German
- Italian
- Spanish
- Custom
- Custom2

3.7.3.3.2. Keypad Selection

Use the Keypad Selection selection box to select the language for the keypad characters that display on the terminal. This selection determines which international characters are available in the alphabetic data entry softkeys. Choices are:

- Dutch
- English
- French/German
- Nordic/German
- Spanish/Italian/Portuguese
- Russian

3.7.4. Transaction Counter

The transaction counter is a seven-digit register that tracks the total transactions that are completed on the terminal. When the value reaches 1,500,000, the next transaction causes a roll-over to 0000001. Use the Transaction Counter setup screen to configure transaction counter operations.

3.7.4.1. Transaction Counter

Use the Transaction Counter selection box to enable or disable the transaction counter.

3.7.4.2. Counter Reset

Use the Counter Reset selection box to enable or disable manual resetting of the counter.



3.7.4.3. Next Transaction

The value for the counter for the next transaction displays in the Next Transaction field. The RESET COUNTER **000** softkey can be assigned to the home screen, giving direct access to the Transaction Counter screen. If Counter Reset is enabled, the counter can be set to 0000000001 by pressing the RESET softkey. A value greater than one can also be entered manually in the Next Transaction field.





3.7.5. Users

The IND560x terminal is pre-configured with two usernames: "admin" and "anonymous". Neither of these usernames has a password. Without passwords, there will be no security challenge for entering setup and making changes. If a password is entered for "admin", a login will be required before changes can be made in setup. These two default usernames cannot be deleted but passwords may be entered for them. All functions of the terminal will be available to all users until a password is entered for the default admin user.

To modify and/or enter a password for a username:

1. Move focus to the username to be edited.
 2. Press the EDIT softkey  to access the User Edit screen.
 3. Press the DOWN navigation key to view the second screen, which displays the Password and Confirm Password fields.
 4. Enter the desired password in the Password and Confirm Password fields.
 5. Press the OK softkey  to accept the password as entered.
 6. Press the ESCAPE softkey  to exit without saving the password.
- Passwords are case-sensitive.
 - All numbers and all characters available in the alpha keys are valid for use in passwords.
 - Be sure to store a record of the password in a safe place. Without the correct password access to the setup menu will not be possible.

To enter a new username and password:



1. Press the INSERT softkey  to access the User Edit screen.
2. Enter the desired username in the Username field.
3. Use the Access selection box to assign the appropriate access level to the user. The following access levels are available:
 - Administrator – An administrator has unlimited access to all set-up parameters in the terminal. There can be multiple administrator users.
 - Maintenance – Next lower level of access.
 - Supervisor – Next lower level of access.
 - Operator – Lowest level of access.
4. Press the DOWN navigation key to view the second screen, which displays the Password and Confirm Password fields.
5. Enter the desired password in the Password and Confirm Password fields.
6. Press the OK softkey  to accept the username and password as entered.
7. Press the ESCAPE softkey  to exit without saving the username and password.
8. Press the DELETE softkey  to delete a username from the table on the Users screen. Usernames "admin" and "anonymous" cannot be deleted.

9. To restore the factory default setting (by deleting all users except the "Admin" and "Anonymous" users and restoring the passwords to null), press the CLEAR softkey **C** and then OK to  confirm the action.

3.7.6. Softkeys

Add or rearrange the softkeys on the terminal's main menu on the softkeys setup screen. Appendix E, Softkey Mapping, provides a more detailed explanation of the softkeys.

When the softkeys setup screen opens, focus is on the softkey position numbers located above the icons.

Two softkeys, INFORMATION RECALL  and SETUP , are automatically placed in the softkey setup. The default setting for the placement of these softkeys is in positions 9 and 10.

The INFORMATION RECALL and SETUP softkeys must always be assigned a position. They can be moved or multiple copies of them can exist but there must always be at least one appearance of them. They cannot be deleted. All other softkeys may be added or deleted as desired.

Adding a softkey to the home pages of the terminal does not automatically enable the softkey's function. Most softkeys must also be enabled in setup too. For instance, adding the UNITS SWITCHING softkey  does not automatically enable units switching – the units must also be enabled in the Scale branch of setup. If a softkey has been added in setup but does not appear on the home page, check that the setup parameters for that function have been enabled.

The following softkeys are available for assignment to the home page:

- | | | |
|--------------------|-----------------------------|------------------|
| • None | • Recall Info* | • Target Start |
| • Alibi Memory | • Repeat Print | • Target Table |
| • Calibration Test | • Reports | • Task 1** |
| • Comparators | • Reset Transaction Counter | • Task 2** |
| • Custom Trigger 1 | • Setup* | • Task 3** |
| • Custom Trigger 2 | • SmartTrac | • Task List** |
| • Custom Trigger 3 | • Tare Table | • Time & Date |
| • ID | • Target | • Unit Switching |
| • MinWeigh | • Target Control | • x10 Display |

* Cannot be removed from home screen or edited.





** Only available when TaskExpert™ or an application is installed.

Press the UP, DOWN, LEFT and RIGHT navigation keys to navigate among the softkey position numbers. Softkeys can be added, removed, and positioned using the softkeys:



Edit

Changes the softkey in the selected position to another softkey or to none, which leaves the softkey position blank. Editing a blank position does not move the position of following softkeys.

-  **Insert** Inserts a softkey into a selected position. All other softkeys located at or after that position increase position number by one.
-  **Delete** Deletes a softkey in a selected position. All other softkeys located at or after that position decrease position number by one.
-  **Clear** Clears all softkey assignments except INFORMATION RECALL  and SETUP  softkeys. These will be shown in positions 1 and 2 respectively.

3.7.7. Reset

The Reset setup screen resets setup values to factory default settings for the Terminal branch of setup.

3.7.7.1.1. Terminal Reset

To initiate a reset, press the OK softkey . If the reset was successful, a verification message that reads "Reset Successful" displays. If the reset was not successful, an error message that reads "Reset Failure" displays. If the reset fails, try to initiate the reset again. If the reset continues to fail, contact a local METTLER TOLEDO representative for assistance.

Press the ESCAPE softkey  to exit without resetting.

3.8. Communication

Setup screens for Communication setup include:

- Templates
- Connections
- Network
- Reports
- Serial
- PLC

Use these setup screens to configure:

- Input and Output Template Setup
- Report Structure
- Connection Assignments
- Serial Port Parameters
- Network Parameters, including Email Alert settings
- PLC Interfaces

3.8.1. Templates

The IND560x terminal utilizes five output templates (1,000 bytes in size) to define the format of data output following a weighing operation.

An input template is also available to receive a string input (such as from a bar code gun) and use it as data entry for ID 1, Tare, Tare ID or

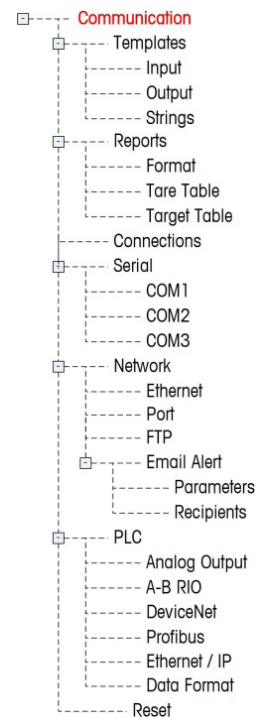

Target ID. When the Fill-560 Application Software is installed, the input template can also be assigned for Target Weigh-In or Target Weigh-out.

A template strings setup screen is also available to configure strings of characters that are frequently used in templates.

3.8.1.1.

Input

Use the Input Template to remove extra characters from an input string of data. Setup parameters include:

Preamble Length – Defines how many characters are skipped at the beginning of an input string before the desired data.

Data Length – Defines the maximum length of a string. All characters beginning after the preamble through the data length selection are used as the input.

Postamble Length – Defines the number of characters (before but not including the termination character) that will be stripped off the data string. All other data from the preamble length to the termination character minus the postamble length are used as the input string. When using an input that is always the same fixed length, this field remains blank.

Termination Character → Used to signal the end of the string input. The termination character can be any ASCII control character. If None is selected, the three-second timeout feature terminates the entry. In addition to None, selections available from the selection box include:

SOH	STX	ETX	EOT	ENQ	ACK	BEL	BS
HT	LF	VT	FF	CR	SO	SI	DLE
DC1	DC2	DC3	DC4	NAK	SYN	ETB	CAN
EM	SUB	ESC	FS	GS	RS	US	

Assignment – Determines how the input data should be used. Choices are:

- ID1
- Keypad
- Tare
- Tare ID
- Target ID
- Target Weigh-in
- Target Weigh-out
- Input populates the ID1 Shared Data variable.
- Used in conjunction with ID Mode – data that would normally be entered using the numeric keypad or on-screen alpha keys may be scanned in during an ID Mode sequence.
- Enters data as a preset tare value
- Uses value as an ID lookup in the tare table
- Uses value as an ID lookup in the target table
- Uses value as an ID lookup in the target table and assigns it as the Active Weigh-in target (Fill-560 feature only)
- Uses value as an ID lookup in the target table and assigns it as the Active Weigh-out target (Fill-560 feature only)

There is also a three-second timeout feature that tracks the amount of time between characters. If this three-second time is exceeded, the string is considered terminated.

3.8.1.2. Output

The Output Template setup screen enables configuration of the output data formats and a header or footer for the Repeat Print function.

To add the “DUPLICATE” designation to a repeat print of an output template, select either Header or Footer from the Repeat Print Field dropdown menu highlighted in Figure 3-18.

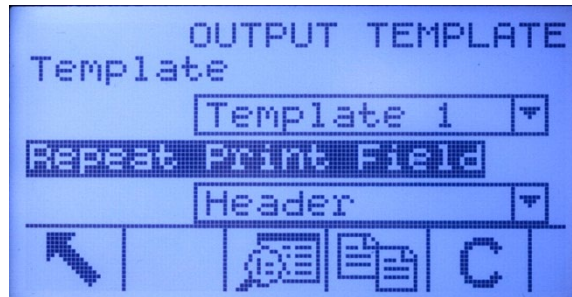



Figure 3-18: Repeat Print Field Setup

To view elements in a template or create a new template, select the desired template from the Template selection box. Five templates are available (Template 1–Template 5).

Press the VIEW TABLE softkey  to access the selected template’s view screen, which lists each element configured for the template.

Press the COPY softkey  to open the copy screen, which enables the elements from one template to be copied to another template.

Press the CLEAR softkey **C** to clear all elements from the selected template. A warning screen displays as a precaution.

Press the EXIT softkey  to return to the menu tree.

Each element is defined by the data type, actual data, justification and length. Elements may be edited, added (inserted), or deleted individually. A leading zero fill function is available for certain fields.

3.8.1.2.1. Editing

1. Press the UP and DOWN navigation keys to select a record to edit.
2. Press the EDIT softkey  to open the setup screen for the record where edits can be made. The element number cannot be edited.
3. Select the element type from the Type selection box. Four element types are available:



CR/LF – A combination carriage return and line feed.

SDName – The name of a Shared Data variable from the terminal.

Special Character – Control characters from a standard ASCII chart. Refer to Appendix G, ASCII Standard and Control Characters.

String – A string of characters to print.

Press ENTER to confirm the element type selection. Depending on which type is selected, additional configuration options will appear.

4. Press the OK softkey  to return to the template setup screen when editing of the element is complete.
5. Press the ESCAPE softkey  to return to the template setup screen without saving the element edits.

Template Editing Options

Table 3-3 lists the editable fields that appear for each Element Type and Format selection. Fields that are not available are indicated with a dash (–).

Table 3-3: Template Element Editing Options

Element Type	Data	Repeat Count	Format	Length	Leading Zero Fill
CR/LF	–	Blank**	–	–	–
SDNAME	Blank* (Refer to Table 3-4)	–	Default	–	–
			Centered, Left	Blank**	–
			Right	Blank**	Enabled/Disabled
Special Character	ASCII character list	–	–	–	–
String	Blank*	Blank**	Default	–	–
			Center, Left, Right	Blank**	–

* Alphanumeric entry field

** Numeric entry field

Repeat Count

A numeric value that sets the number of times the Data will repeat. For example, if the string data entered is an asterisk (*), a repeat count value of 20 would produce a row of 20 asterisks:

Format & Length

The Format & Length options are Default, Centered, Left, and Right. These describe the justification of the data within the length of the field.

The Default value is fixed, and Length cannot be defined here.

For SD name and String data, the Centered, Left and Right formats are accompanied by a Length field. After choosing the format, focus moves to the Length entry box. This value determines how long the element will be – the data will be positioned within a string of the length entered. Refer to the Notes on Format & Length, below.

Leading Zero Fill

In the case of Right-formatted SDName data, Leading Zero fill may be enabled or disabled. Normally, Leading Zero Fill will be disabled, which means spaces will be used to fill in leading non-significant data. If enabled, Leading Zero Fill will fill in any leading spaces of the data with zeroes. The following examples of 4 characters in output data defined as 8 characters long show the use of Leading Zero Fill:

Leading Zero Fill disabled:					.	1	2	3
Leading Zero Fill enabled:	0	0	0	0	.	1	2	3

Notes on Format & Length

If data for an element includes more characters than the value entered for Length, the output data will be cut off. For example, if the number of characters entered under format on the Output Template Edit Screen is six, and data for a string that contains eight characters is entered, only six of the characters from the data string will print. If data for a string that contains four characters is entered, all of the characters from the data string will print.

The characters and alignment of the printed data are defined by the selected format:

Example 8-character string of ABCDEFGH in a 6-character element:

Center:

B	C	D	E	F	G
---	---	---	---	---	---

Prints the middle six characters from an eight-character string – drops first and last characters.

Left:

A	B	C	D	E	F
---	---	---	---	---	---

Prints the first six characters from an eight-character string – drops the last two characters.

Right:

C	D	E	F	G	H
---	---	---	---	---	---

Prints the last six characters from an eight-character string – drops the first two characters.

Example 4-character string of ABCD in a 6-character element:

	A	B	C	D	
--	---	---	---	---	--

Space Space

Prints all four characters from a four-character string in a centered position, leaving a space at the beginning and a space at the end.

A	B	C	D		
---	---	---	---	--	--

Spaces

Prints all four characters from a four-character string in a left-justified position, leaving two spaces at the end.

		A	B	C	D
--	--	---	---	---	---

Spaces

Prints all four characters from a four-character string in a right-justified position, leaving two spaces at the beginning.

In Table 3-4, where dashes appear in the SDName (e.g. sd--08), this means that there are more than one instance of the share data variable. The instance number appears in place of the dashes (e.g. sd0308, for the third comparator's target comparison operator). For a full list of Shared Data

fields, please refer to the IND560 Terminal Shared Data Reference (document # 64058660) found on the documentation CD.

Table 3-4: Example Shared Data Names for Use in Templates

IND560x Data Field	SDName	Length (A/N = alphanumeric)
Terminal		
Scale ID	cs0103	20 A/N
Base Serial Number	ce0138	13 A/N
Terminal Serial Number	xs0105	13 A/N
Terminal ID#1	xs0106	20 A/N
Terminal ID#2	xs0107	20 A/N
Terminal ID#3	xs0108	160 A/N
Current Date	xd0103	11 A/N
Current Time	xd0104	11 A/N
Transaction Counter Value	xp0101	9 A/N
Grand Total Value	tz0101	12 A/N
Grand Total Count	tz0102	9 A/N
Subtotal Value	tz0103	12 A/N
Subtotal Count	tz0104	9 A/N
ID Mode Prompts 1-20	pr0131-pr0150	20 A/N
ID Mode Prompt Responses 1-20	pa0101-pa0120	51 A/N
Message 01, 02, etc.	aw0101, aw0102..	100 A/N
Templates 1 - 5*	pt0101– pt0105	As programmed
Template Strings 1–20	pt0111 – pt0130	51 A/N
Targets		
Target Description	sp0101	20 A/N
Target Value	sp0105	12 A/N
Target Units	sp0120	3 A/N
Fine Feed	sp0110	12 A/N
Spill Value	sp0109	12 A/N
+ Tolerance Value (weight)	sp0111	12 A/N
– Tolerance Value (weight)	sp0112	12 A/N
+ Tolerance Value (%)	sp0114	12 A/N
– Tolerance Value (%)	sp0115	12 A/N
Comparator names 1-5	sd--01	21 A/N
Comparator target coincidence values 1 - 5	sd--05	12 A/N
Comparator target comparison operators 1-5	sd--08	5 A/N

IND560x Data Field	SDName	Length (A/N = alphanumeric)
Comparator second weight range values 1-5	sd--09	12 A/N
Comparator second weight range comparison operators 1-5	sd--10	5 A/N
Weights		
Scale Mode (Gross/Net)	ws0101	1 A/N (G or N)
Tare Source Description	ws0109	2 A/N "T<space>", or "PT"
Displayed Tare Wt.	ws0110	12 A/N
Displayed Gross Wt.	wt0101	12 A/N
Displayed Net Wt.	wt0102	12 A/N
Displayed Wt. Units	wt0103	3 A/N
3 rd Weight Unit Gross Weight	wt0104	13 A/N
3 rd Weight Unit Net Weight	wt0105	13 A/N
3 rd Units	wt0106	3 A/N
Displayed Rate	wt0108	13 A/N
Rate Time Units	cs0107	1 A/N
Rate Weight Units	cs0108	1 A/N
Custom Unit Name	cs0112	12 A/N
Custom Unit Conversion Factor	cs0113	12 A/N

- * Using a template field code within another template will insert the entire template into the new template.

Printing Multiple Weight Units

Note that if a third weight unit is defined, it can be named in a template so that it appears in the output data together with the displayed unit. However, if the third unit is currently displayed on the terminal, it will appear twice in the data output. Therefore, if the output is to include both primary and 3rd weight units, ensure that the primary unit data is displayed when the data output is initiated.

- Secondary Units are not available for multiple unit printing.

Inserting

Press the UP and DOWN navigation keys to select a location in the list of elements to insert a new element. Press the INSERT softkey  to open the setup screen to create a new record. Configure the parameters as described under Editing. All following elements are moved down one position.

Deleting

Press the UP and DOWN navigation keys to select an element to delete. Press the DELETE softkey  to delete the element.

Test Printing

Press the TEST PRINT softkey  to perform a test print of the template being configured.

3.8.1.3.



Strings

The Template Strings setup screen defines strings of characters that are frequently used in template messages. Template strings can be viewed, edited, inserted, deleted, or printed.

To view template strings:



1. Use the Search Field selection box to select ID or String and enter information in the Data field to limit the search, or do not enter any search limits to view all template strings.
2. Press the START SEARCH softkey . The String Search View screen displays the search results. Only records with non-null values display. Records are ordered by ID, with the lowest ID number shown first.
3. Press the UP and DOWN navigation keys to scroll up and down the screen in order to view all strings listed.

Editing

- Note that not all keyboard characters are available when entering information using the IND560x keypad. However, characters such as ~ and | can be included in a template created using the InSite software. They will be recognized by the IND560x when the template is downloaded, will display correctly, and will be included in the template when it is printed.
 - The [,] and {, } characters have been added to the list of characters available from the terminal softkeys. These characters can be found in firmware versions 3.02 and higher.
1. Press the UP and DOWN navigation keys to select (highlight) the string record to be edited.
 2. Press the EDIT softkey  to open the record for editing. The edit screen will be shown with focus on the "Text" label. This is the only editable field on the screen. The ID number cannot be changed.
 3. Press ENTER to access the text field. The alpha keys will display.
 4. Use the alpha keys and the numeric keypad to edit the string. A string can be a maximum of 50 characters.
 5. Press ENTER when complete.
 6. Press the OK softkey  to accept the edited record and return to the String Search View screen.
 7. Press the ESC softkey  to return to the String Search View screen without accepting the changes to the string.

Inserting



1. Press the INSERT softkey  to create a new record. An edit screen will be shown with "ID" and "Text" labels.
2. Press the UP and DOWN navigation keys to select the field to enter.
3. Press ENTER to access the field. When entering the ID field, the value shown is the first unused ID.
4. Use the numeric keypad to enter an ID number from 1 to 20.

5. Press ENTER when complete. If the ID entered already exists, an error display will be shown. The error must be acknowledged and a new ID entered.
6. If the TEXT field is entered, the alpha keys will display. Use the alpha keys and the numeric keypad to edit the text string.
7. Press ENTER when complete.
8. Press the OK softkey  to accept the new record and return to the String Search View screen.
9. Press the ESC softkey  to return to the String Search View screen without accepting the new record.

Deleting

Press the DELETE softkey  to delete a template string from the list.

Printing

1. Press the PRINT softkey  to print the list.
2. Press the EXIT softkey  to return to the String Search Screen.
3. Press the EXIT softkey  again to return to the menu tree.

3.8.2. Reports

The reports setup screens enable configuration of the structure of tare and target table reports that are generated by the IND560x terminal. The reports setup screens include:

- Format
- Tare Table
- Target Table

3.8.2.1. Format

Use the selection box for the Format field to select the width of the reports

- Narrow (40) – 40 character-wide reports
- Wide (80) – 80 character-wide reports

3.8.2.1.1. Header

The Header field specifies the number of blank lines (CR/LF) to be placed at the start of each report.

3.8.2.1.2. Title

The Title selection box enables a default title line to be printed at the top of the report. Time and date will print in the format selected at Terminal > Region > Format Time & Date.

3.8.2.1.3. Record Separator

A repeated character may be selected as a separator between printed records in the report. This step selects the character to be used. The character choices in the selection box are:

- None (no separator between records) = (equal symbols)
- * (asterisks) CR/LF (blank line)
- (dashes)

For example, if * (asterisks) is selected, the resulting line separator will appear as follows:

3.8.2.1.4. Footer

The Footer field specifies the number of blank lines (CR/LF) to be placed at the end of each report.

3.8.2.2. Tare Table

Use this setup screen to select which fields in the Tare Table will print when a Tare Table Report is printed. The ID field is always printed; it cannot be disabled. Fields that can be enabled or disabled include:

- Tare
- n (number of transactions)
- Description
- Total (accumulated total tare weights)

3.8.2.3. Target Table

Use this setup screen to select which fields in the Target Table will print when a Target Table Report is printed. The ID field is always printed; it cannot be disabled. Fields that display and that can be enabled or disabled vary depending on how the Target Table is configured (as described in the Application branch under Memory setup).

Fields available include:

- Description
- +/- Tolerances
- Fine Feed
- Target
- Spill
- +/- Limits

■ If the Target mode is disabled, this branch cannot be expanded.

3.8.3. Connections

The IND560x comes standard with a single, intrinsically safe serial port (COM1). Additional ports are available by:

- Installing the current loop or fiber optic interface and using COM4 and/or COM5 to communicate with an ACM500 safe area communication module. When using the ACM500 module with the Ethernet/COM2/COM3 option installed, serial ports COM2 and COM3 and Ethernet connections Ethernet1, Ethernet2, Ethernet3 and EPrint become available.

■ NOTE: Always power up the ACM500 before turning on the power to the IND560x. This will ensure that the IND560x will communicate correctly with the ACM500 and recognize all installed options.

- Installing the intrinsically safe current loop interface option into the IND560x and using COM4 and/or COM5 directly. In this application, the COM4 and COM5 ports can be used to

communicate with the ACM200 safe area communication module or with an IND226x used as remote display.

- Installing the fiber optic interface option into the IND560x and using COM4 and/or COM5 directly. In this application, the COM4 and COM5 ports can be used to communicate with the legacy dual channel fiber optic converter, A100, 8624, or directly to another IND560x or Puma terminal used as a remote display.

3.8.3.1. COM4 and COM5

As explained above, the COM4 and COM5 communication ports can be used as standard serial ports directly or can be dedicated to communicate with the ACM500 module. The first decision to make regarding connections to the IND560x is determining how these two ports will be used. The Connections screen (Figure 3-19) shows the connection options for COM4 and COM5.

- **NOTE:** The COM4/COM5 Connection page is visible in setup even if NO interface board has been installed into the IND560x. If NO interface board is installed, the assignments for COM4 and COM5 must be "Disabled".



Figure 3-19: COM4 and COM5 Setup

3.8.3.1.1. To edit the COM4 or COM5 connection

1. Press the UP and DOWN navigation keys to select (highlight) the appropriate port, COM4 or COM5.
2. Press the ENTER key to edit the desired port.
3. Use the UP and DOWN keys to choose a connection type from the selection box.
4. Press the ENTER key to accept and save the connection parameter.

Table 3-5: Available COM4/COM5 Port Connections

Port	Connection	Function
COM4	Disabled	Port will not be used
	Standard	Port will be used directly with ACM200, Fiber Optic converter or IND226x
	ACM500	Port will be used to communicate with ACM500 for COM2, COM3 or PLC connectivity
COM5	Disabled	Port will not be used
	Standard	Port will be used directly with ACM200, Fiber Optic converter or a remote IND226x
	ACM500	Port will be used to communicate with ACM500 for Ethernet TCP/IP connectivity

The correct selection depends on what the IND560x will be communicating with over COM4 and/or COM5. Table 3-6 provides an overview of what the COM4 and COM5 settings should be for the various peripheral communication devices that work with the IND560x.

Table 3-6: COM4/COM5 Setup for Various Communication Modules

Peripheral Communication Device	Correct COM Connection	Application Notes
None	Disabled	No communication intended over COM4/COM5
ACM200 Module (Communication available over current loop interface only)	COM4 = Standard and/or COM5 = Standard	The ACM200 provides a single RS-232 port in the safe area. Two ACM200 modules can be supported simultaneously, one each on COM4 and COM5.
Legacy Fiber Optic Converter 0964-0043 0964-0052 0964-0058 0964-0059 0964-0060	COM4 = Standard and/or COM5 = Standard *1 or 2 communication channels may be required. Dependant on legacy setup.	The FO converter supports one or two channels of RS-232 or 20mA communication in the safe area. This selection would be used when replacing a Puma, ID3sTx, 8141 or 8525 terminal that is communicating to a fiber optic converter.
IND226x (Communication available over current loop interface only)	COM4 = Standard and/or COM5 = Standard	The IND226x with Interface-Remote installed can be used as a remote display inside the hazardous area. Only one of the two available ports is required for this functionality.
ACM500	COM4 = ACM500 and/or COM5 = ACM500 *Only 1 channel required in some cases.	The ACM500 can provide PLC and COM2/COM3/Ethernet communications in the safe area. Refer to the Installation Manual for details of which port is required for which option.

After the appropriate COM4 and/or COM5 connection has been made, proceed to the Connections View setup screen for further port assignments by pressing the VIEW TABLE softkey .

If the port connection type has changed for COM4 or COM5, the IND560x will force a power cycle so that the IND560x will correctly communicate with any safe area communication devices. The IND560x will display a popup message indicating that a power cycle is about to take place (Figure 3-20). At this point, the operation cannot be cancelled. Setup must be entered again to view the port assignments.

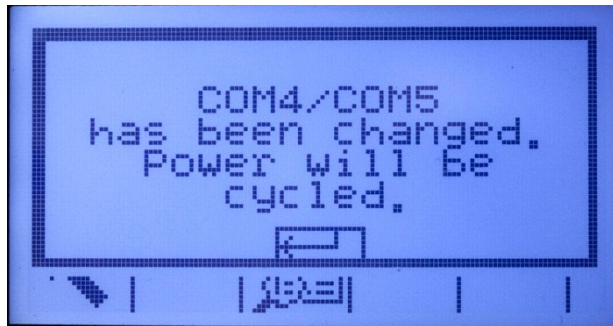



Figure 3-20: COM4/COM5 Power Cycle Message

Proceed in setup to Communications>Connections and again press the VIEW TABLE softkey  to enter the Connections View area where ports can be assigned.

3.8.3.2.

Reconnect Mode

The communication protocol between the IND560x and the ACM500 requires that the ACM500 be powered up first. If the ACM500 experiences a power cycle, the message shown in Figure 3-21 will display. In the past when this occurred, users were required to acknowledge this pop-up message by pressing the ENTER key. Users were then further required to manually power cycle the IND560x to re-establish communication between the terminal and the ACM500.



Figure 3-21: ACM500 COM Error Message

A new setting in v3.04 firmware and higher provides the user with two options to re-establish communication automatically in the event of an ACM500 power loss. In setup, Communication > Connections includes a new setting called Reconnect Mode. Available settings include Manual and Automatic.

Manual When Manual is selected, the operator will be presented with two options when the ACM500 communication error (Figure 3-21) is shown on-screen. Pressing ESC will acknowledge and clear the error message, but no further action will be taken by the IND560x terminal. If OK is pressed, the error message is acknowledged and the IND560x will complete a power cycle in order to re-establish communication with the ACM500.

Automatic If Automatic is selected, the ACM500 communication error pop-up message will not display on-screen and the user will not be given a choice of when the IND560x

will go through a power cycle. Instead, once the IND560x detects that the ACM500 is back on line, the IND560x will automatically power cycle itself.

3.8.3.3. Communication Port Assignment

The Connections View setup screen (Figure 3-22) defines what type of communication will occur over each port. If no connections are programmed, nothing will be available on the COM ports or Ethernet ports.



Figure 3-22: Connections View Screen

Ports available for assignment can include the standard serial port COM1, optional COM2, COM3, COM4 and COM5 serial ports, the optional Ethernet ports, and the optional E-print port. The availability of all optional ports depends on the selections for COM4/COM5 on the Connections page as well as optional interfaces installed in the ACM500.

Various COM4/COM5 setup combinations exist. Table 3-7 shows the available ports available for additional assignment based on the initial setup selections for COM4 and COM5.

Table 3-7: Ports Available for Various COM4/COM5 Combinations

COM4 = Standard / COM5 = Standard	
Available Port	COM1, COM4, COM5
Ports Not Available	COM2, COM3, Ethernet 1,2,3, Eprint
COM4 = Standard / COM5 = ACM500	
Available Port	COM1, COM4, Ethernet 1,2,3, Eprint
Ports Not Available	COM2, COM3, COM5
COM4 = ACM500 / COM5 = Standard	
Available Port	COM1, COM2, COM3, COM5
Ports Not Available	Ethernet 1,2,3
COM4 = ACM500 / COM5 = ACM500	
Available Port	COM1, COM2, COM3, Ethernet 1,2,3, Eprint
Ports Not Available	COM4, COM5

The following functions are available via softkeys on the Connections View screen:

- Editing
- Inserting

- Deleting
- Clearing

To edit or insert connection assignments:





1. Press the UP and DOWN navigation keys to select (highlight) a connection assignment in the list.
2. Press the EDIT softkey  to open the setup screen for editing a specific connection assignment or press the INSERT softkey  to create a new connection assignment.
3. Parameters configured in the connections screen include the port and the type of input or output assignment. Depending upon these selections the remaining fields will vary but could include the trigger, the template to be sent, and if checksum will be sent or not.
4. Press the UP and DOWN navigation keys to move the focus to the field to be edited or added.
5. Press the ENTER key to select a field to edit or add.
6. Use the selection boxes for each field to select the port, associated assignment, and desired settings for the connection. Available selections are indicated in Table 3-8, organized by Port and Assignment.

Table 3-8: Available Parameters, by Port and Assignment



Port	Assignment	Trigger	Template	Checksum	# of Nodes
COM1 COM2 COM3 COM4 COM5	ASCII Input, CTPZ Input, Reports, SICS, Shared Data Server*, Remote Display				
	Continuous Output			Disabled, Enabled	
	Continuous Template		Template 1...5		
	Demand Output, Totals Report	Scale, Trigger 1...3	Template 1...5		
	Remote Discrete I/O				0, 1, 2, 3
Ethernet 1	Continuous Output			Disabled, Enabled	
	Continuous Template		Template 1...5		
	Demand Output, Totals Report	Scale, Trigger 1...3	Template 1...5		
	Reports				
Ethernet 2 Ethernet 3	Demand Output	Scale, Trigger 1...3	Template 1...5		
EPrint	Continuous Output			Disabled, Enabled	
	Continuous Template		Template 1...5		
	CTPZ Input, SICS				
	Demand Output	Scale, Trigger 1...3	Template 1...5		
Print Client	Continuous Output			Disabled, Enabled	
	Continuous Template		Template 1...5		
	Demand Output	Scale, Trigger 1...3	Template 1...5		

Connection options notes:

- Not all choices are available for all connection assignments. Only valid choices are shown in the selection boxes on the IND560x terminal.
- The Shared Data Server assignment is only available on COM1. Serial connection to the Shared Data Server is only possible on COM1. This assignment allows a user to connect to the Shared Data Server over COM1 without turning SW2-1 to the "on" position.

- **IMPORTANT:** Appropriate signal barrier is required when connecting a non-intrinsically safe device, such as a PC, to the intrinsically safe COM1 on the IND560x. Entity parameters must be confirmed to ensure the appropriate barrier has been selected.
 - The Trigger field displays only when the assignment selection is Demand Output. The Trigger 1, 2, and 3 selections for Trigger enable connection of a discrete input or a PLC command to trigger the output of the selected template. The discrete selection must be programmed separately (as described in the Application branch under Discrete I/O).
 - The Template field displays only when the assignment selection is Demand Output, Continuous Template, or Totals Report. Only one template can be assigned to each connection.
 - The default template for the Totals Report is Template 5.
 - The Checksum field is available for continuous outputs only.
 - The SICS selection provides some Level 0 and Level 1 interface commands.
 - If usage conflicts occur, a pop-up message will display and the IND560x terminal will not allow the conflicted assignment to be saved.
 - EPrint offers a method to access the demand or continuous output data directly through the Ethernet port. Shared Data Server login and commands are not required to register for the data. The data output string does not include any Shared Data Server response messages, and reflects only the configured demand template data or the continuous output string. The EPrint port is accessible only through the Ethernet interface's secondary port, which can be configured in setup at Communication > Network > Port.
 - The # of Nodes refers to the number of ARM100 Remote I/O modules that will be connected in series to the IND560x.
7. Press the OK softkey  to accept the connection parameters and return to the Connections setup screen when editing or adding the connection assignment is complete.
 8. Press the ESCAPE softkey  to discard the connection parameters and return to the Connections setup screen without saving the connection assignment edits or additions.

Press the DELETE softkey  to delete a connection assignment from the Connections list.

To clear all connection assignments in the Connections list, press the CLEAR softkey  then press OK  to confirm the action.

Press the EXIT softkey  to return to the menu tree.

3.8.4. Serial

Serial communication setup screens provide access to the communication parameters for the serial ports COM1, COM2, COM3, COM4 and COM5.

- **NOTE:** The COM2 and COM3 ports are only shown if the Ethernet/Serial option board has been installed in the ACM500.
- **NOTE:** The COM4 and COM5 ports can only be changed if their connection setup selection is "Standard".
- If "Remote Discrete I/O" is selected as the port assignment at Communication > Connections, the port parameters are automatically preset and cannot be changed.

3.8.4.1. COM1, COM2, COM3, COM4 and COM5

Use the COM1, COM2, COM3, COM4 and COM5 setup screens to configure the parameters for serial ports.

3.8.4.1.1. Baud

Use the Baud selection box to set the baud rate for the serial port. Options are:

300	1200	4800	19200	57600
600	2400	9600	38400	115200

3.8.4.1.2. Data Bits

Use the Data Bits selection box to set the data bits to either 7 or 8 for the serial port.

3.8.4.1.3. Parity

Use the Parity selection box to set the parity to None, Odd, or Even for the serial port.

3.8.4.1.4. Flow Control

Use the Flow Control selection box to set the flow control to either None or XON-XOFF (software handshaking).

■ After an XOFF command is received on a serial port configured for XON/XOFF handshaking, data remaining in the port's buffer will still be sent. Port buffers contain the following amounts of data:

- COM1: 16 bytes
- COM2: 64 bytes
- COM3: 64 bytes
- COM4: 64 bytes (when set as "Standard", not "ACM500")
- COM5: 64 bytes (when set as "Standard", not "ACM500")

3.8.4.1.5. Interface

Use the Interface selection box to select the serial port interface. Selections include:

- RS-232
- RS-422
- RS-485

■ COM4 and COM5 are limited to RS-232 only.

3.8.5. Network

Network setup screens include Ethernet, Port, FTP and Email Alert.

3.8.5.1. Ethernet

Ethernet is available for TCP/IP transfer of data, shared data server access, connection via the EPrint port, email alerts, FTP and saving and restoring configurations with InSite™ SL. The Medium Access Control (MAC) Address cannot be edited; it is shown for information only. Setup for Ethernet allows static Internet Protocol (IP) addressing or DHCP (Dynamic Host Configuration Protocol). If

the (Dynamic Host Configuration Protocol) DHCP Client setting is enabled, the IP Address, Subnet Mask, and Gateway Address fields are assigned automatically by the network and become read-only in the setup screens.

Use the UP and DOWN navigation keys to select the field to be edited. Press the ENTER key to edit the field or selection choice. The Ethernet branch includes the following fields:

3.8.5.1.1. DHCP Client

The DHCP client can be enabled or disabled. If disabled, the IP address must manually be assigned in the following fields. If enabled, the terminal will be assigned an IP address by the network server. The IP address can then be viewed in the following fields.

3.8.5.1.2. IP Address

Enter the IP address (or view if DHCP Client is enabled) for the IND560x terminal. After each group of digits has been entered, press ENTER to proceed to the next group. The default value for the IP is 192.68.0.1.

3.8.5.1.3. Subnet Mask

Enter the subnet mask (or view if DHCP Client is enabled) for the IND560x terminal. After each group of digits has been entered, press ENTER to proceed to the next group. The default value for the subnet mask is 255.255.255.0.

3.8.5.1.4. Gateway Address

Enter the gateway address (or view if DHCP Client is enabled) for the IND560x terminal. After each group of digits has been entered, press ENTER to proceed to the next group. The default value for the gateway is blank.

After entry is complete, press the EXIT softkey  to return to the menu tree

3.8.5.2. Port

The Port setup screen displays the primary Ethernet port number and also allows a secondary port number to be configured for the same Ethernet interface. The primary port is reserved for the Shared Data Server access. The secondary port allows for either Shared Data Server access or EPrint connections, if configured. The primary and secondary ports can be used concurrently.

3.8.5.2.1. Primary Port

The Primary Port number for the Ethernet TCP/IP interface is fixed at 1701, and is displayed as a read-only field in the Port setup screen (Figure 3-23). The Primary Port number can be modified through a Shared Data write. Refer to the IND560 Shared Data Reference Manual found of the Documentation CD for details.

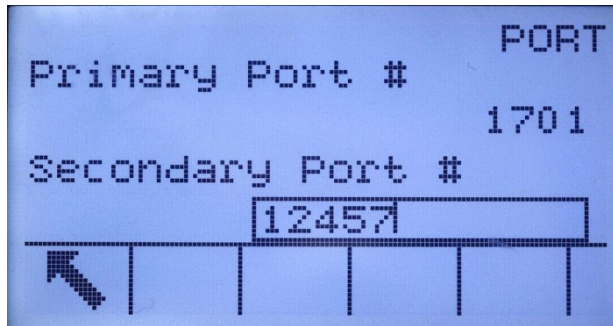

Figure 3-23: Secondary Port Setup





3.8.5.2.2. Secondary Port #

If a valid, user-defined Secondary Port number is entered, the Shared Data Server will also be accessible on a second TCP/IP port. However, if an EPrint connection is configured in setup at Communication > Connections, Shared Data Server access is no longer be available on this port, which will be used entirely for the EPrint demand or continuous types of output. A change to the Secondary Port number may require a manual power cycle of the terminal before the change becomes active.

3.8.5.3. FTP

The setup screen for FTP displays usernames and access levels for file download. Usernames can be edited, inserted, or deleted.



3.8.5.3.1. To edit or insert a username

1. Press the UP and DOWN navigation keys to select (highlight) a username in the table.
 2. Press the EDIT softkey  to open the setup screen for editing a username or press the INSERT softkey  to open the setup screen to create a new username.
 3. Press the ENTER key to select the Username field. The alpha keys display.
 - The Username field is accessible only when entering a new FTP user.
 4. Use the alpha keys to edit or enter the desired username.
 5. Use the Access selection box to assign the appropriate access level to the user. The following access levels are available:
 - Operator
 - Supervisor
 - Maintenance
 - Administrator
 6. Press the DOWN navigation key to view the second screen, which displays the Password and Confirm Password fields.
 7. Enter the desired password in the Password and Confirm Password fields.
 8. Press the OK softkey  to accept the username and password as entered.
 9. Press the ESCAPE softkey  to exit without saving the username and password.
- Press the DELETE softkey  to delete a username from the table on the Users screen.

To clear all usernames from the list and leave only the default username "admin", press the CLEAR softkey **C** then OK  to confirm the action.

3.8.5.4. Print Client

The Print Client connection allows the IND560 to send data to a specific IP address on the same network as the IND560. To set up Print Client:

1. At Communication >Network > Print Client – enter the Server IP Address and Server TCP Port number. The Server IP Address is the IP address of the device where the IND560 is sending the print information. The Server TCP Port is the port number of the device on the network.
2. At Connections, press the INSERT  softkey to define a new connection.
3. Under Port, scroll to Print Client and press ENTER.
4. Under the Assignment and Checksum fields, make desired selection.
5. Press the OK  softkey to save the settings.

3.8.5.5. Email Alert

The IND560x can be configured to send email alerts when it encounters a calibration change or calibration failure that might indicate a hardware problem, or when calibration expires. Note that the Ethernet connection used to send email alerts is separate from those configured at Communication > Connections.

3.8.5.5.1. Parameters

This screen permits four parameters to be set:

SMTP Server IP

This value is set using four groups of numbers, representing the IP address of the mail server the IND560x will use to send alerts. Default is 0.0.0.0.

Sender Email Address

This is an alphanumeric entry field permitting the IND560x's email address to be set. Default is blank.

Sender Name





This is an alphanumeric entry field, used to give the IND560x a unique name that will appear in the "From" field of alert emails. Default is "IND560x."

Subject Line

This alphanumeric entry field defines the Subject field of the email to be set. Default is "Scale Cal Alert."

3.8.5.5.2. Recipients

This screen is used to define recipients of email alerts, together with the condition under which they will receive an email. The following actions are available on the Email Recipients screen:

Softkey	Function	
	EXIT	Returns to the setup menu tree.
	EDIT	Opens the Email Recipients Edit screen, permitting parameters for the selected recipient to be edited.
	NEW	Opens the New Email Recipient screen, allowing a new recipient to be defined.
	DELETE	Deletes the selected recipient.
	TEST	Sends an email alert message, titled "Email Alert Test Message," to the recipient currently selected.

The NEW and EDIT screens offer the same options:

Email Address

This alphanumeric entry field is used to enter the recipient's email address. Default is blank. Up to 6 recipients can be configured.

- Note – use the decimal key  on the IND560x front panel to enter the period in each email address.

Alert On

Available options are None, All, Failures. The default is None. Table 3-9 lists all the events that trigger an email alert. Messages sent when Alert On is set to Failures are indicated by an asterisk.

Table 3-9: Calibration Alerts

Event	Email Message Subject
Completion of CalFree calibration	CalFree complete
After each step in step calibration	Calibration complete
Calibration expired	Calibration expired*
Failing a calibration test	Cal. test failed*
Passing a calibration test	Cal. test passed
Completion of a zero capture from the Calibration page	Zero captured
Completion of a span capture from the Calibration page	Calibration completed

3.8.6. PLC

The PLC parameters are only available when a PLC option is installed in the ACM500. PLC setup screens include:

- Analog Output
- A-B RIO (Discontinued, January 2021)
- DeviceNet (Discontinued, December 2022)
- PROFIBUS
- EtherNet/IP
- Modbus TCP
- Data Format

3.8.6.1. Analog Output

The analog output of the IND560x terminal provides either 4 - 20 mA or 0 - 10 volt DC outputs depending on how the connection is wired. The output can be configured to represent either the displayed weight or the gross weight.

To configure analog output:

1. Choose the appropriate source from the Source field selection box. Selections are:

- None
- Application (Source as defined by a Task Expert application)
- ABS - Displayed Wt.
- ABS – Rate*
- Displayed Weight
- Gross Weight
- Rate*

*Available only when Rate is enabled

2. Select either None or Scale from the Channel selection box. A selection of None disables the output.
3. On the second screen of this setup branch, the zero and span values for the analog output can be adjusted. These values can be for weight or rate, depending on the selected source. In the Zero Value field, enter the value at which the “zero” output of the analog signal should occur.
4. If these preprogrammed values do not provide the exact outputs required, they may be trimmed by using the ZERO and SPAN softkeys located at the bottom of the screen as follows:
5. Press the ZERO softkey to initiate the zero fine-tuning process or the SPAN softkey to initiate the span fine-tuning process. In either case, a warning screen offers two options – OK to continue with the operation, or EXIT to return to the Analog Output screen without making any adjustment.
6. The analog output signal value will change during this procedure – ensure that the PLC or other control equipment is disconnected. A warning message displays asking for verification to continue.
7. Once the OK softkey  has been pressed, the zero fine-tuning or span fine-tuning operation begins. A message screen appears, showing the current value of the analog output signal. Use the softkeys that display to adjust the signal if necessary as follows:

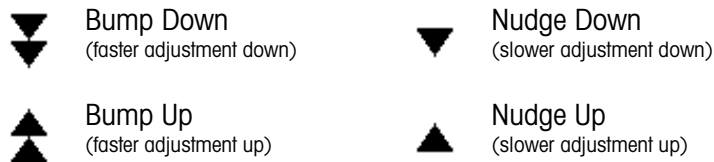

8. Press the EXIT softkey  to return to the previous screen.

3.8.6.2. A-B RIO

- The Allen Bradley RIO interface was discontinued in January 2021. The AB-RIO information in this manual is provided to support legacy installations only.

The Allen-Bradley Remote I/O (A-B RIO) network is an Allen-Bradley proprietary network protocol that permits certain PLCs to communicate to additional racks of input and output devices or to other peripheral devices that implement the RIO interface.

Additional interface information and programming examples can be found in the **IND560 Terminal PLC Interface Manual**, which is included on the documentation CD.

The A-B RIO setup screen is used to configure A-B RIO as a PLC interface option.

3.8.6.2.1. Node Address

Each IND560x Terminal connected to the network represents one physical node; however, the addressing of the node is defined as a logical rack address. This address is determined by the system designer, then configured in the IND560x Terminal by selecting the Node Address text box and using the numeric keypad to enter the appropriate node address (0–62).

Prior to the Node Address text box is a selection field allowing the user to enter the node address in either:

- Decimal
- Octal

Figure 3-24 shows the new A-B RIO setup screen for Node Address.

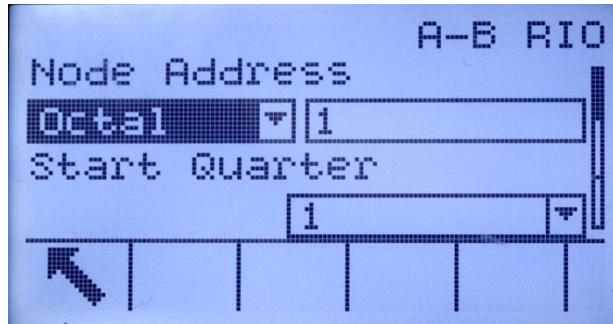

Figure 3-24: A-B RIO Node Address Setup Screen

3.8.6.2.2. Start Quarter (Group)

Each scale occupies a quarter rack (single group) in the RIO address space and the quarter (group) may be defined as the first (0), second (2), third (4), or fourth (6) quarter (group) of a rack. Designate the location of the PLC that is the highest quarter used in a logical rack by using the selection box to select the appropriate start quarter address 1–4 (group 0–6).

3.8.6.2.3. Last Rack

The IND560x configuration selections enable designation of the last rack. Use the selection box to select Disabled or Enabled for last rack designation.

3.8.6.2.4. Data Rate

Use the selection box to select the desired data rate. Selections available are:

- 57.6 Kb
- 115.2 Kb
- 230.4 Kb

3.8.6.2.5. Block Transfer

Use the Block Transfer selection box to either Disable or Enable the block transfer mode of operation.

3.8.6.3. DeviceNet

■ The DeviceNet interface was discontinued in December 2022. The DeviceNet information in this manual is provided to support legacy installations only.

The DeviceNet Interface can be configured to run up to 500Kbits per second depending on cabling and distances. Messages are limited to 8 un-fragmented bytes. The network can include up to 64 nodes including the master, commonly called the scanner. The DeviceNet setup screen is used to configure DeviceNet as a PLC interface option.

Additional interface information and programming examples can be found in the IND560 Terminal PLC Interface Manual, which is included on the documentation CD.

3.8.6.3.1.

Node Address

Each IND560x Terminal connected to the network represents one physical node. This address is determined by the system designer, then configured in the IND560x Terminal by selecting the Node Address text box and using the numeric keypad to enter the appropriate node address (0–63). The default address is 63.

3.8.6.3.2.

Data Rate

Use the selection box to select the desired data rate. Selections available are:

- 125 Kb
- 250 Kb
- 500 Kb

125 kB is the default value.

3.8.6.4.

PROFIBUS DP

The PROFIBUS DP Interface supports discrete data transfer that enables bi-directional communication of discrete bit-encoded information or 16-bit binary word (signed integer) numerical values.

Additional interface information and programming examples can be found in the IND560 Terminal PLC Interface Manual, which is included on the documentation CD.

The PROFIBUS setup screen is used to configure PROFIBUS as a PLC interface option.

3.8.6.4.1.

Node Address

Each IND560x Terminal connected to the network represents one physical node. This address is determined by the system designer, then configured in the IND560x Terminal by selecting the Node Address text box and using the numeric keypad to enter the appropriate node address (0–125).

3.8.6.4.2.

Shared Data

The Shared Data parameter enables or disables an extended message length that includes shared data access. This data is added to the end of the standard scale slot information and extends the message length.

Use the Shared Data selection box to select Disabled or Enabled for shared data message communication.

3.8.6.5.

EtherNet/IP

EtherNet/IP, short for “EtherNet Industrial Protocol,” is an open industrial networking standard that takes advantage of commercial, off-the-shelf EtherNet communication chips and physical media. This networking standard supports both implicit messaging (real-time I/O messaging) and explicit messaging (message exchange). The interface enables the IND560x terminal to communicate with EtherNet/IP Programmable Logic Controllers (PLCs) through direct connection to the EtherNet/IP network at either 10 or 100 MBPS speed.

EtherNet / IP interface has the following features:

- User-programmable IP addressing.
- Capability for bi-directional discrete mode communications (Class 1 Messaging) of weight or display increments, status, and control data between the PLC and the IND560x.

Additional interface information and programming examples can be found in the IND560 Terminal PLC Interface Manual, which is included on the documentation CD.

3.8.6.5.1. MAC Address

The Terminal's MAC address in the Ethernet / IP network is assigned automatically.

3.8.6.5.2. IP, Subnet Mask and Gateway Address

The Terminal's IP Address, Subnet Mask and Gateway Address are chosen by the system designer. Default values are as follows:

IP Address: 192.168.0.1

Subnet Mask: 255.255.255.0

Gateway Address: 0.0.0.0

3.8.6.6. Modbus TCP

Additional interface information and programming examples can be found in the IND560 Terminal PLC Interface Manual, which is included on the documentation CD. The Modbus TCP setup screen is used to configure this PLC interface option.

3.8.6.6.1. MAC Address

The Terminal's MAC address in the Modbus TCP network is assigned automatically.

3.8.6.6.2. DHCP Client

The DHCP Client is enabled by default. If disabled, the IP address must be assigned manually. If enabled, the terminal will be assigned an IP address by the network server.

3.8.6.6.3. IP, Subnet Mask and Gateway Address

The Terminal's IP Address, Subnet Mask and Gateway Address are configured as described in Ethernet setup, above.

3.8.6.7. Data Format

Use the Data Format setup screen to configure the PLC data format.

3.8.6.7.1. Format

Select the desired PLC format from the Format field selection box. Selections include:

- Divisions - PLC format that provides scale increment data transfer.
- Floating Point - PLC format that provides 32-bit floating point data transfer in 16-bit integer format.
- Integer - PLC format that provides 16-bit integer data transfer.

3.8.6.7.2. Byte Order

Select the desired byte order field selection box. Selections are:

- Word Swap - Default value. Takes the single-precision floating point format and swaps the two words in the 32-bit double word. This format is compatible with RSLogix 5000 processors.
- Byte Swap - Makes the floating point format compatible with S7 Profibus.
- Historic - Makes the floating point format compatible with PLC 5 (selection only available with A-B RIO interface)
- Double Word Swap - Makes the data format compatible with the Modicon Quantum PLC for Modbus TCP networks (this selection is only available with EtherNet/IP and Modbus TCP interfaces).

Table 3-10: Available Selections, by PLC Interface

	A-B RIO	PROFIBUS	DeviceNet	Ethernet / IP Modbus TCP
Standard		x	x	x
Word swap	X	x	x	x
Byte swap	X	x	x	x
Historic	X			
Double Word Swap		x	x	x

Table 3-11: Byte Order

		Word Swap	Byte Swap	Double Word Swap	Standard / Historic
Weight value, terminal		1355			
PLC		15 Bit # 0	15 Bit # 0	15 Bit # 0	15 Bit # 0
Number, Integer/Division	Weight value Word	0x054B Hex	0x4B05 Hex	0x4B05 Hex	0x054B Hex
Floating point	First weight value Word	0x6000 Hex	0xA944 Hex	0x0060 Hex	0x44A9 Hex
	Second weight value Word	0x44A9 Hex	0x0060 Hex	0xA944 Hex	0x6000 Hex

3.8.6.7.3. Message Slots

This parameter refers to the number of slots of data that will be transferred. Typically only one slot is used in a single scale application, but sometimes an application requires multiple fields of data in a cyclic data transfer. In order to accomplish this, two, three, or even four message slots can be assigned for the output. As the number of message slots is increased, so is the length of the message, because each slot requires enough memory to transmit a complete set of data. More detailed information can be found in the IND560x Terminal PLC Interface Manual, which is included on the documentation CD.

Choose the number of message slots from the selection box. Press ENTER when done.

3.8.7. Reset

The Reset setup screen restores Communication branch setup values to their factory default settings.

3.8.7.1.1. Communication Reset

To initiate a reset, press the OK softkey . If the reset was successful, a verification message that reads "Reset Successful" displays. If the reset was not successful, an error message that reads "Reset Failure" displays. If the reset fails, try to initiate the reset again. If the reset continues to fail, contact a local METTLER TOLEDO representative for assistance.

Press the ESCAPE softkey  to exit without resetting.

3.9. Maintenance

The maintenance setup branch includes:

Configure/View of the log files and calibration test

Running diagnostics or the calibration test

3.9.1. Configure/View

The Configure/View setup branch includes the following screens:

- Change Log
- Maintenance Log
- Calibration Management
- Calibration Test
- Reset



3.9.1.1. Change Log

Change Log



The change log file tracks all changes to setup and shared data. The Change Log is approximately 150k bytes in size. Each record could vary in length, but an average of about 2,500 records can be saved.

Use the selection box on this setup screen to select Disabled or Enabled for the change log.

To reset all records in the change log file:

1. Press the RESET softkey . A warning message displays asking for verification that all configuration change records are to be reset.
2. Press the OK softkey . The configuration change records history is reset.
3. If the reset was successful, a verification message that reads "Reset Successful" displays. If the reset was not successful, an error message that reads "Reset Failure" displays. If the reset fails, try to initiate the reset again. If the reset continues to fail, contact a local METTLER TOLEDO representative for assistance.
4. Press the ESCAPE softkey  to return to the Change Log screen.

To view change log records:

5. Press the VIEW TABLE softkey . The Change Log Search screen displays.
6. Use the Search Field 1 and Search Field 2 selection boxes and associated data fields to enter specific search information to limit the search by date, shared data (SDName), Time, or Username, or enter * (the "find all" character) to view all Change Log information.
7. Press the START SEARCH softkey . The Log Search View screen displays with the search results sorted in chronological order (The most recent change record displays at the end of the file with focus. Older records may be viewed by pressing the UP navigation key.).

Information displayed in the Change Log View includes:

- Time Stamp
- Username

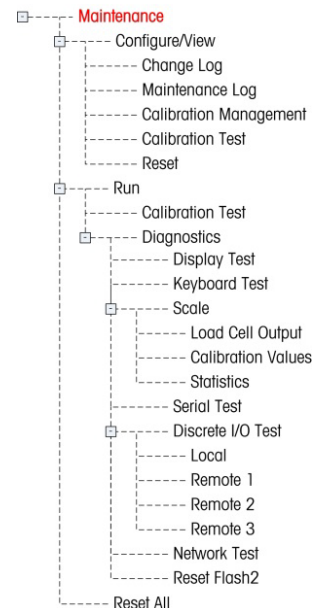

- Shared Data Field Name
- New Value

8. Press the PRINT softkey  to print the list to all Report connections.

9. Press the EXIT softkey  to return to the Change Log Search Screen.

3.9.1.2. Maintenance Log

The maintenance log is a record of routine maintenance or activities such as capture span and capture zero. Use the selection box on this setup screen to select Disabled or Enabled for the maintenance log.



The Maintenance Log is approximately 150k bytes in size. Each record can vary in size, but an average of about 2,500 records can be saved.

Reset all records or view records in the Maintenance Log by following the same steps described for Change Log.

Information that displays on the Maintenance Log Search View screen includes:

- Time Stamp
- Username
- Event
- Status

3.9.1.2.1. New Maintenance Log Entry

The NEW softkey  on the Maintenance Log screen opens an ADD MAINTENANCE RECORD screen, intended to record the upgrade or repair of equipment. From this screen, an Event may be added, removed or replaced, and its status recorded in an 8-character alphanumeric entry field. Press OK  to confirm the change, or ESC  to exit the screen without changing the Maintenance Log.

3.9.1.3. Calibration Management

Calibration management includes a test interval to program how much time elapses or how many weighments should be completed between calibration checks. When this time or number of weighments is exceeded, an expiration action is initiated. The type of expiration action is also programmable. This feature is disabled by entering zeroes into both the number of days and number of weighments entry boxes.

Use the Calibration Management setup screen to configure parameters used for managing calibration activities.

3.9.1.3.1. Test Interval

Specify test intervals in days or weighments in the corresponding field text boxes.

The expiration action will be triggered when the first of either of these values is reached. For example, if 30 days and 3,000 weighments were programmed, as soon as 30 days or 3,000 weighments were exceeded (whichever were first), the expiration action would occur.

3.9.1.3.2. On Expiration

Use the On Expiration selection box to configure the activity to occur upon expiration of the calibration after the next test date or number of weighments occurs. Settings include:



- a. No Action
- b. Alarm Only (displays an expiration message)
- c. Alarm & Disable (displays expiration message and disables the scale)

Note that, regardless of how the On Expiration option is configured, a pop-up message will appear over the home screen when calibration expires.

3.9.1.3.3. Last Date Tested, Next Test Date, and # of Weighments Left

The Last Date Tested and Next Test Date (if days is specified for intervals), or the number of weighments left until the next service (if weighments is specified for intervals), automatically calculate and display.

To reset the Last Date Tested to the current date:

1. Press the RESET softkey .
2. A warning message displays asking for verification that calibration management values are to be reset.
3. Press the OK softkey . A status screen displays that shows the reset process status. The Last Date Tested is reset to the current date. This reset also generates a recalculation of the Next Test Date and/or # of Weighments Left parameters if test intervals have been entered for these fields.
4. If the reset was successful, a verification message that reads "Values Reset OK" displays. If the reset was not successful, an error message that reads "Reset Failed" displays.
5. Press the ESCAPE softkey  to return to the Calibration Management screen.

3.9.1.4. Calibration Test



The calibration test provides a prompting, scale test sequence to help lead the person performing the test through a test sequence. A test load with +/- tolerance is programmable for each step along with two lines of prompting directions to guide the test person through each step. Up to 25 steps can be programmed for the sequence.

Use the Test Load Units selection box to select calibration test load units. Only weight units available for primary units are available for selection.



The entire calibration test sequence can be cleared by pressing the CLEAR softkey, then pressing OK to confirm the action. When the calibration test sequence is cleared (empty), it still shows the –End– step. The –End– record will always display as the last step of the calibration test sequence. This field cannot be deleted and cannot be edited.

Press the VIEW TABLE softkey  to access the current calibration test sequence setup. The Calibration Test View screen displays.



When the Calibration Test View screen opens, the step numbers and their associated test loads, tolerances, and prompts display. Calibration test steps can be configured by:

 Editing  Inserting  Deleting

To edit a calibration step:

1. When the Calibration Test setup screen opens, the first step in the list will have focus. Use the UP and DOWN navigation keys to select a step to edit.
2. Press the EDIT softkey  to open the setup screen for the step where edits can be made.
3. The step's test load and tolerance data displays first. Information for Prompt Field 1 and Prompt Field 2 (up to 20 characters per field that display as separate lines during the calibration test) display on the next screen. Edit the test step's test load, tolerance, and prompts as desired.
4. Press the OK softkey  to accept the calibration step parameters as entered.
5. Press the ESCAPE softkey  to return to the Calibration Test View screen without saving the changes to the calibration step parameters.

To insert a calibration step:

6. Use the UP and DOWN navigation keys to select the step in the calibration test procedure where the new step is to be inserted.
7. Press the NEW softkey  to open the setup screen to create a new calibration test step.
8. Enter the step's test load and tolerance data and information for Prompt Field 1 and Prompt Field 2.
9. Press the OK softkey . The current screen data is stored at the indicated step number, and any existing steps move down one record to make room for the new step.
10. Press the ESCAPE softkey  to return to the Calibration Test View screen without saving the calibration step.

Use the UP and DOWN navigation keys to select a step to delete. Press the DELETE softkey  to delete the step.

Press the PRINT softkey  to print the calibration test steps.

Press the EXIT softkey  to return to the Calibration Test screen.

3.9.1.5. Reset

The Reset setup screen resets setup values to factory default settings for the Maintenance Configure/View setup.

3.9.1.5.1. Maintenance Reset

To initiate a reset, press the OK softkey . If the reset was successful, a verification message that reads "Reset Successful" displays. If the reset was not successful, an error message that reads "Reset Failure" displays. If the reset fails, try to initiate the reset again. If the reset continues to fail, contact a local METTLER TOLEDO representative for assistance.

Press the ESCAPE softkey  to exit without resetting.

3.9.2. Run









The Run screens enable the operator to:

- Run the calibration test
- View and run diagnostic tests



3.9.2.1. Calibration Test





The name of the person who previously ran the calibration test displays on the Run Calibration Test screen. Press the ENTER key to change the name. Use the alpha keys to enter a new name. Press ENTER.

To view and modify test weight information:

1. Press the TEST WEIGHT INFORMATION softkey  to access the Test Weight View screen where test weight information such as weight values and serial numbers can be edited, inserted, or deleted.
2. Press the EDIT softkey  to change a weight value or ID for a test weight, or press the NEW softkey  to insert a weight value and ID for a new test weight.
3. Press the OK softkey  to save the changes or the new test weight record.
4. Press the ESCAPE softkey  to exit without saving.
5. Press the DELETE softkey  to delete a test weight from the list.
6. To clear all test weight records from the list, press the CLEAR softkey , then OK  to confirm the action.
7. Press the EXIT softkey  to return to the Run Calibration Test screen.

To run the calibration test:

8. Press the START softkey  to initiate the calibration test. The currently displayed weight unit is compared to the programmed calibration test procedure weight unit.
 - If the units do not match, the IND560x terminal will automatically check other programmed units and switch to the corresponding weight unit. If the unit selected for calibration does not match the primary, second, or third units, an error message will display and the test cannot be run. If this occurs, reprogram the unit selection or the calibration test unit to ensure that they match.
9. Live scale weight (active weight) displays on the first line (under the system line).
10. The calibration test step (for example, 1/5, which indicates step 1 of 5) displays under the active weight display.
11. The next line displays the test load value and +/- tolerance values for the step.
12. Prompt 1 displays on the line under the test load.
13. Prompt 2 displays on the next line.
14. Follow the prompts on the display and add the required test weights.
15. Press the OK softkey  to proceed to the next calibration test step.

16. If a tolerance fails at any step, a Calibration Test Tolerance Failure message displays. Press ENTER to acknowledge the error. There are now three possible steps:
 - a. If the wrong test weights were added to the scale, adjust the weights and press the OK softkey  to repeat the steps.
 - b. If the test weights were correct and the scale needs to be recalibrated, press the ESCAPE softkey  to abort the calibration test.
 - c. Press the SKIP softkey  (a new softkey that displays when a Calibration Test Tolerance Failure occurs), to accept the calibration test error and continue to the next step. This step of the test will still report as a failure, but the test can be run to completion if desired.
17. After progressing through all of the steps in the calibration test procedure, a Test Complete message displays along with a Status message of either Pass or Fail. Press the PRINT softkey  to print the calibration test report to connections with a Report assignment.
18. Press the ESCAPE softkey  during any step to abort the calibration test and return to the Run Calibration Test screen.

3.9.2.2. Diagnostics

Diagnostic test setup screens include:

- Display Test
- Keyboard Test
- Scale
 - - Load Cell Output
 - - Calibration Values
 - - Statistics
- Serial Test
- Discrete I/O Test
 - - Local
 - - Remote I/O 1
 - - Remote I/O 2
 - - Remote I/O 3
- Network Test
- Reset Flash 2

3.9.2.2.1. Display Test

The Display Test screen displays an alternate off/on dot block pattern when first accessed. After the alternate off/on cycle, any additional test data about the display such as memory or program information displays.

Press the EXIT softkey  to return to the menu tree.

3.9.2.2.2. Keyboard Test

The Keyboard Test screen enables testing of the terminal keys, including:

- Softkeys
- Scale function keys
- Navigation keys
- Numeric keys

Press any key. The screen will display the key last pressed.

Press the EXIT softkey  to return to the menu tree.

3.9.2.2.3. Scale

Scale diagnostics setup screens include:

- Load Cell Output
- Statistics
- Calibration Values

Load Cell Output

The Cell Output screen displays the current number of counts (active value) for the scale. This display is only available for analog load cells.

Press the EXIT softkey  to return to the menu tree.

Calibration Values

The Calibration Values screen displays the current calibration values configured for the scale. The number of test loads that display calibration values is determined by the Linearity Adjustment setting configured for the scale (see the Scale branch, Calibration setup; this display is not available for IDNet and SICSpro scale types).

These calibration values can be recorded and then manually entered into a new replacement board should a failure ever occur, which eliminates having to recalibrate the scale with test weights. While this method is quick, it is not as accurate as placing test weights on the scale.

Use the UP and DOWN navigation keys to select a calibration value to be modified. Use the numeric keypad to enter new values.

Press the EXIT softkey  to return to the menu tree.

Statistics

The Scale Statistics screen displays statistical information for the scale such as weighments (increments each time a transaction is triggered), overloads (increments when the applied load for a single load cell exceeds its overload capacity), peak weight (the maximum weight recorded by the scale), and zero commands (increments each time a zero command is received from an operator or remotely).

Use the UP, DOWN, LEFT, and RIGHT navigation keys to view all information and records.

Press the EXIT softkey  to return to the menu tree.



3.9.2.2.4. Serial Test

The Serial Test screen enables testing of the sending and receiving hardware on the serial ports COM1, COM2, and COM3.

Com Port

Use the Com Port selection box to select the COM1, COM2 or COM3 serial port for testing .

NOTE: COM4 and COM5 cannot be tested in this manner.

Press the START softkey  to initiate transmission of the test string. After pushing the START softkey , it changes to a STOP softkey . Press this key to end transmission of the test string.

In the serial test mode, the terminal will transmit a string "Testing COMX nn" out the selected serial port where the "X" is the selected com port number (1, 2, or 3) and "nn" is a sequential two-digit number (00–99). If a jumper is placed between the transmit and receive terminals on that port, the same data displays in the receiving field.

If another device is connected to the receiving port, any ASCII data received displays in the receiving field.

The serial test continues until the STOP softkey  is pressed, which returns the user to the main Serial Test screen.

Press the EXIT softkey  to return to the menu tree.

3.9.2.2.5.

Discrete I/O Test

Discrete I/O Test setup screens include:







- Local
- Remote I/O 1
- Remote I/O 2
- Remote I/O 3

Select the internal (local) or external (Remote I/O) to be tested from the menu tree. Press ENTER.

■ **VERY IMPORTANT!** When any of the Discrete I/O Test screens are first accessed, a warning message displays with instructions to remove output control power before proceeding with the test. The Discrete I/O Test screens enable manual setting of any of the outputs to on or off for testing, so it is necessary to remove output control power before proceeding.

Press the ESCAPE softkey  to abort and not perform the test.

To continue the test:

1. Press the OK softkey . A real-time display shows the status of each of the inputs and enables each of the outputs to be turned on and off. An input or output that displays  is turned off. An input or an output that displays  is turned on.
2. Use the LEFT and RIGHT navigation keys to select an output to turn on or off.
3. Press the DISCRETE OFF softkey  to turn the output off, and press the DISCRETE ON softkey  to turn the output on.
4. Press the EXIT softkey  to return to the menu tree. The outputs return to their previous on/off configuration before the tests were initiated.

5. If three remote I/O modules are set up in the terminal, the IND560x disables the ability to run diagnostics on a local I/O board that may be installed.

3.9.2.2.6. Network Test

The Network Test screen enables Ethernet network testing and assists in determining the availability of network options. The status of each line associated with the network setup displays during and after testing, showing a status of either Testing, Pass, Fail, or Timeout.

Press the EXIT softkey  to return to the menu tree.

3.9.2.2.7. Reset Flash 2

The reset Flash 2 function clears the Flash 2 memory of all TaskExpert program files, custom tables and bitmap files specific to TaskExpert custom programs that have been downloaded to the terminal. Only the A1.csv (Tare Table csv file), A2.csv (Target Table csv file) and A3.csv (Container Tare Table csv file present in the Fill-560 only) will remain in place and intact during a reset of the Flash 2 drive.

Press the START softkey  to initiate a reset of the Flash 2 memory. The terminal will NOT prompt the user for confirmation and the reset will begin immediately. A "Reset successful" pop-up will appear when the reset is complete. Press ENTER to acknowledge. At this time, the terminal will complete a power cycle.

Press the EXIT softkey  to abort and not perform the reset.

3.9.2.3. Reset All Factory Default Settings

The Reset All setup screen resets all setup settings to factory default settings.

- The Reset All step resets all parameters in the terminal, except metrologically significant settings such as Scale type, capacity, etc.

When the Reset All screen is first accessed, a message displays that asks for verification to reset all setup parameters to factory default settings. To continue with the Reset All, press the OK softkey . If the reset was successful, a verification message that reads "Reset Successful" displays. If the reset was not successful, an error message that reads "Reset Failure" displays. If the reset fails, try to initiate the reset again. If the reset continues to fail, contact a local METTLER TOLEDO representative for assistance.

Press the ESCAPE softkey  to exit without resetting.

3.10. Restoring Factory Default Settings

Factory default settings can be restored individually for branches such as scale, application, and terminal, or globally with the Reset All screen under the Maintenance branch. The Reset screen is the last branch in each major branch of the menu tree (except for Maintenance). To restore factory default settings for Terminal, for example:

1. Press the SETUP softkey . The setup menu tree displays (see Figure 3-25).

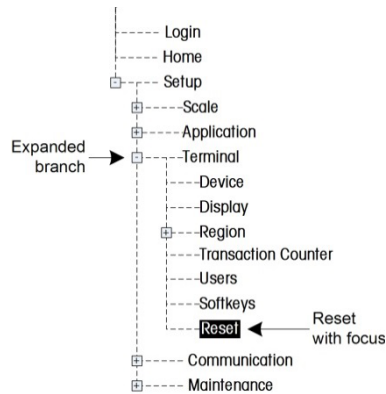



Figure 3-25: Setup Menu Tree – Reset

2. Use the DOWN navigation key to move the focus to Terminal.
 3. Press the RIGHT navigation key to expand the Terminal branch.
 4. Use the DOWN navigation key to move the focus to Reset.
 5. Press the ENTER key to open the Terminal Reset screen.
 6. Press the OK softkey  to reset the Terminal setup values to factory default settings.
 7. A status message appears that verifies a successful reset.
 8. Press the EXIT softkey  to return to the setup menu tree display.
 9. Repeat steps 2–8 to reset factory default settings for any major branch in setup.
- Select Reset All under Maintenance to restore all setup settings to factory defaults. Note that neither this, nor Scale Reset, includes the reset of Type, Capacity, Increment, or Calibration data. Reset this data by setting SW2-1 to its ON position, and then performing a master reset by turning SW1-1 and SW1-2 ON and then cycling power to the terminal.

4 Service and Maintenance

The IND560x terminal is designed to provide years of dependable operation. However, METTLER TOLEDO recommends that – as with any industrial measurement equipment – the IND560x terminal and the connected scale system be serviced periodically. Timely, factory specified maintenance and calibration by a METTLER TOLEDO service technician will ensure and document accurate and dependable performance to specifications.



If unexpected problems do occur, METTLER TOLEDO recommends that service be done only by qualified, trained personnel. To assist in this repair, record as much information as possible about what has happened including any error messages and physical responses of the terminal and/or scale.

4.1. Terminal Cleaning and Maintenance

To clean the IND560x terminal's keypad and cover:

- Gently wipe the IND560x terminal's keypad and cover with a clean, damp, soft cloth.
- Use water or mild, non-abrasive cleaning agents.
- Do not use any type of acids, alkalis or strong industrial solvents such as toluene or isopropanol (IPA) that could damage the terminal's finish.
- Do not spray cleaner directly on the terminal.
- Do not clean the terminal using high-pressure or high-temperature water.
- Build-up of dust layers must be avoided.
- Remove light dust deposits using a damp cloth with a gentle wiping motion.
- Do not use compressed air or vacuum to remove dust layers.
- Follow good housekeeping practices to keep the terminal clean.

Regular maintenance inspections and calibration by a qualified service technician are recommended.

	 WARNING
	IF THE IND560X KEYBOARD, DISPLAY LENS OR ENCLOSURE IS DAMAGED, THE DEFECTIVE COMPONENT MUST BE REPAIRED IMMEDIATELY. REMOVE POWER IMMEDIATELY AND DO NOT REAPPLY POWER UNTIL THE DISPLAY LENS, KEYBOARD OR ENCLOSURE HAS BEEN REPAIRED OR REPLACED BY QUALIFIED SERVICE PERSONNEL. FAILURE TO DO SO COULD RESULT IN BODILY HARM AND/OR PROPERTY DAMAGE.

4.1.1. Overlay and Gasket

The IND560x is a rugged stainless steel enclosed instrument; however, the front panel is a polyester covering over sensitive electronic switches and a lighted display. Care should be taken to avoid any punctures to this surface or any vibrations or shocks to the instrument.



The overlay should be inspected during maintenance, and replaced if it is damaged. Should the front panel overlay become punctured, the IND560x should be taken out of service until the overlay can be replaced.

- To maintain IND560x terminal's gasket seal on Harsh and Panel enclosures:
 - Inspect gasket for tearing, deterioration and damage each time the Harsh enclosure is opened.
 - Replace gasket when removing the panel version terminal from panel.

4.2. Service

Only qualified personnel should perform installation, programming, and service. Please contact a local METTLER TOLEDO representative for assistance.

In general, once the IND560x is installed, programmed, and calibrated for a given application, only routine calibration service is required.

	 WARNING
	ONLY PERMIT QUALIFIED PERSONNEL TO SERVICE THE TERMINAL. EXERCISE CARE WHEN MAKING CHECKS, TESTS AND ADJUSTMENTS THAT MUST BE MADE WITH POWER ON. FAILING TO OBSERVE THESE PRECAUTIONS CAN RESULT IN BODILY HARM AND/OR PROPERTY DAMAGE.

4.2.1. General Safety Guidelines for Service

When performing on-site service or maintenance, only carry out this work on the weighing terminal in the hazardous area if the following conditions are fulfilled:

- The certification papers (conformity certificates, control drawing, manufacturer certifications, etc.) are present and can be used to confirm the correctness and safety of the installation
- The intrinsically safe entity parameters and area approval of the individual components are in accord with one another,
- The customer has issued a permit ("spark permit" or "fire permit")
- The area has been rendered safe and the owner's safety coordinator has confirmed that there is no danger
- The necessary tools and any required protective clothing are provided (danger of the build-up of static electricity)

4.3. Display Messages

4.3.1. Application Key Error

If, on power-up, the terminal finds that the hardware application key status has changed, a fault message (Figure 4-1) will display. For instance, if the Fill-560 hardware key was added to a standard IND560x, the fault would be displayed at power up.



Figure 4-1: Application Key Fault Message

Even though the ENTER graphic is shown, the ENTER key does not function. Two responses to this error are possible:

- If the hardware key status was not changed on purpose, turn power off and determine what caused the status to change. Fix the problem and apply power again. The terminal will retest the hardware key status.
 - If the hardware key status was changed on purpose by adding or removing a key, perform a manual Master Reset – refer to Master Reset under Troubleshooting, below.
- NOTE: Back up the terminal's current setup parameters before the hardware key status is changed. The original setup can then be downloaded to the terminal after the Master Reset has been performed.

4.3.2. COM4 Error / COM5 Error

A "COM4 Error" and/or "COM5 Error" message will display in the system line of the IND560x (Figure 4-2) if:

- The setting at Communication > Connections > COM4 or COM5 is ACM500, and the IND560x does not register communication from the ACM500 when it is powered up, or
- Communication is lost between the IND560x and ACM500.

For troubleshooting assistance, refer to the Internal Diagnostic Testing section later in this chapter.

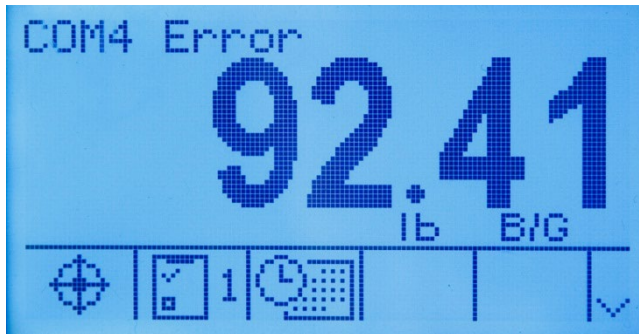

Figure 4-2: COM4 and COM5 Communication Errors

4.3.3. Invalid Parameters

The IND560x might display an “Invalid Parameters” message in the system line when exiting the setup menu (Figure 4-3). This will happen when the weighing mode has been set to “Over/Under” at Application > Memory > Target Table > Mode and there is no active Target value established. As long as a Target is setup up by recalling a record from the Target Table or manually setting up a value with the Target softkey, the “Invalid Parameters” message will no longer appear.

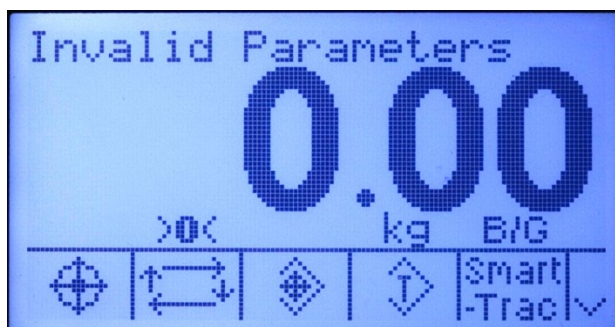

Figure 4-3: Invalid Parameter Message

4.3.4. Battery Alarm

When the battery voltage falls to its shut-off level, a message will appear on screen – “ALARM – Low Battery! Power off is in process!” This message will display for ten seconds, after which the terminal will power off automatically.

4.4. Setting a Custom Language

The IND560 terminal allows custom languages to be selected for display messages.
Troubleshooting

Troubleshooting for the IND560x includes:

- Internal Diagnostic Testing

4.4.1. Internal Diagnostic Testing

The IND560x provides several internal diagnostic tests that are accessible in setup mode. Press the SETUP softkey  to view the setup menu tree. Use the DOWN navigation key to scroll down the

menu tree to Maintenance. Press the RIGHT navigation key to expand the menu tree selections for Maintenance. Scroll down and expand Run. Scroll down and expand Diagnostics. Available diagnostic setup screens include the following.

4.4.1.1. Display Test

Displays an alternate off/on dot block pattern when accessed. After the alternate off/on cycle, the display will return to the menu tree.

4.4.1.2. Keyboard Test

Enables testing of the keyboard. Each key that is pressed will be shown on the display. When testing is complete, press the EXIT softkey  to return to the menu tree.

4.4.1.3. Scale

4.4.1.3.1. Load Cell Output

Displays the current load cell output (active weight) for the scale. This is useful to determine exactly how many counts the analog section is outputting and is not available with IDNet and SICSpro bases.

4.4.1.3.2. Calibration Values



Displays the current calibration values for the scale. If these values are recorded after a scale calibration, and the Main PCB is replaced in the future, the calibration values can be manually entered here to “transfer” the previous calibration to the new Main PCB. This is not available with IDNet and SICSpro bases.

4.4.1.3.3. Statistics

Displays statistical information for the scale such as the total number of weighments, the number of scale overloads, the peak weight weighed on the scale, total number of zero commands and failed zero commands. These are very helpful when diagnosing scale problems.

4.4.1.4. Serial Test

Enables testing of the transmit and receive functions on serial ports COM1, COM2 and COM3 (if installed in ACM500). COM4 and COM5 on the fiber optic and current loop interfaces of the IND560x can also be tested in this manner with special conditions.

1. Place a jumper wire between the transmit and the receive terminals of the COM port to be tested as shown in Figure 4-4.
2. Select the COM port (COM1, COM2, COM3) to be tested using the selection box for COM Port. Only the ports installed are available for testing.
3. Press the START softkey  and a data string is output repeatedly approximately once every three seconds. The data is: [Testing COMx: nn] where “x” is the COM port and “nn” is an incrementing value beginning at 00 and continuing to 99. Each transmission increments this number by one.
4. The same data string that is transmitted displays as the receiving field. If another device is connected to the receiving port, any ASCII data received displays in the receiving field.
5. To stop the serial port test, press the STOP softkey .

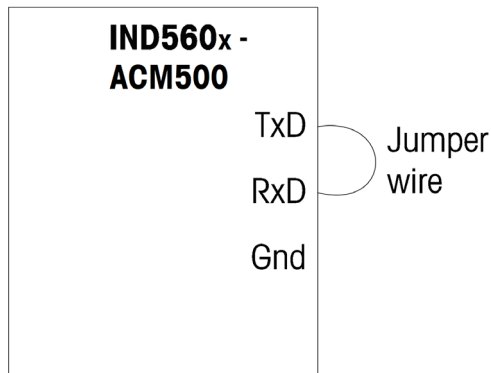



Figure 4-4: Jumper Wire Between Transmit and Receive Terminals on COM1

4.4.1.5. Discrete I/O Test

Provides a view of the status of the discrete inputs and allows enabling or disabling of the discrete outputs for diagnostic purposes. Expand the Discrete I/O branch by pressing the RIGHT navigation key. Choose if the test will be performed on the local (internal) discrete I/O option or one of the remote ARM100 modules. Press ENTER when that branch is highlighted.

Next, a warning will display to remind the tester that the outputs can be turned on manually during this test, so any control power to the discrete outputs should be removed.

	 WARNING
	<p>THE DISCRETE OUTPUTS OF THE IND560X TERMINAL WILL BE MANUALLY ENABLED DURING THIS TEST. REMOVE OUTPUT CONTROL POWER SO EXTERNAL EQUIPMENT WILL NOT BE ENERGIZED BY MISTAKE. EXERCISE CARE WHEN MAKING CHECKS, TESTS AND ADJUSTMENTS THAT MUST BE MADE WITH POWER ON. FAILING TO OBSERVE THESE PRECAUTIONS CAN RESULT IN BODILY HARM AND/OR PROPERTY DAMAGE.</p>

When viewing the test screen, the input status will be shown at the top of the display and the output status will be shown at the bottom of the display Figure 4-5). Focus is shown on Output #1 first.

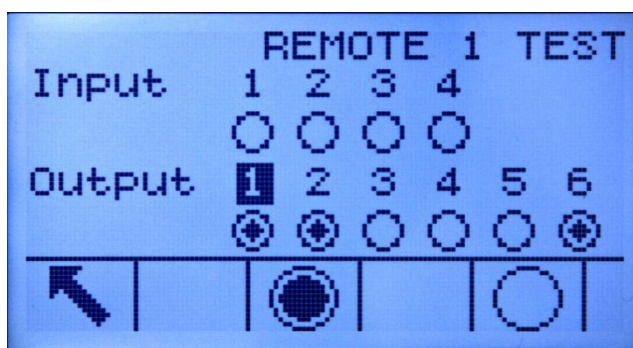

Figure 4-5: Discrete I/O Test Screen

Focus can be moved to any of the other outputs by using the RIGHT and LEFT navigation keys. The two softkeys at the bottom of the page will either enable ● or disable ○ the highlighted output.

- Note that when the Discrete I/O Test screen is exited, all outputs will be turned off again.

4.4.1.6. Network Test

Enables testing of the Ethernet programming/hardware/firmware in the terminal. The following tests are run during this diagnostic process:

- TCP/IP Stack
- This IP Address
- Gateway address

Each step will indicate “Testing” during the test then indicate a Pass or Timeout status. If the status is shown as Timeout, it indicates that the IP address or gateway address has not been programmed in the terminal (refer to Communication I Network in Chapter 3, Configuration for information on entering the IP and gateway addresses).

4.5. External Diagnostics

4.5.1. Web Server

The IND560x includes a built-in web server utility that provides valuable tools for examining the operation of the terminal, its installed options and software. Information available in the Web Server includes:

- System hardware and software configuration
- Resource utilization
- Scale statistics and data

Web server help can also be used for the following functions:

- Reading shared data variables, viewed either statically or dynamically
- Writing shared data values
- Remote terminal reset

The Web Server in the IND560x is accessed with a web browser via the Ethernet connection installed in the ACM500. Access to the Terminal is provided by using its IP address. An IP address can be manually assigned, or assigned automatically by the network, depending on how DHCP is configured in setup at Communication > Network > Ethernet. If DHCP client is enabled, once the terminal is connected to the Ethernet its IP address will appear in the Ethernet configuration screen.

After an IP address for the IND560x has been entered or automatically assigned using DHCP, record the address and enter it as the URL in the browser.

If the connection was successful, the Web Server home page (Figure 4-6) is displayed.

4.5.1.1. Home Page

When the Web Server is first accessed, the Home page shown in Figure 4-6 appears in the browser window.

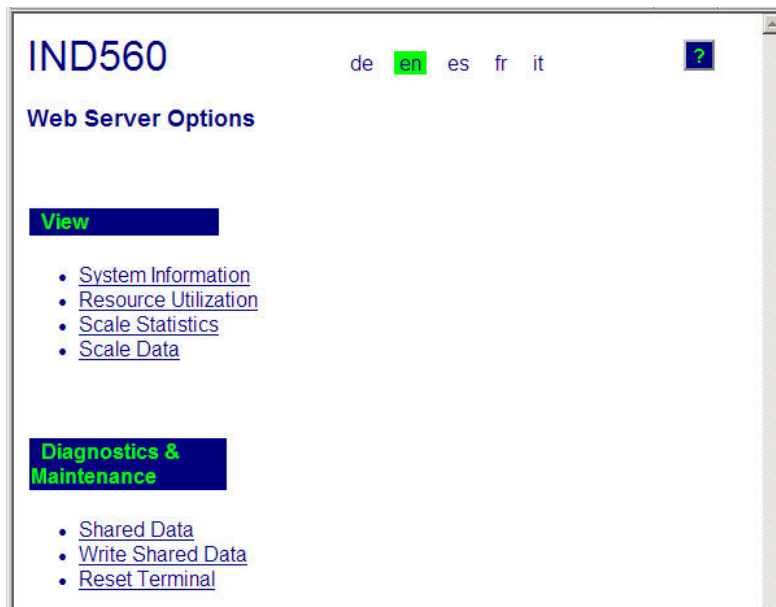

Figure 4-6: Web Server Home Screen

Click the links on this page to visit the respective views, each of which is detailed in the following sections.

At the bottom of each page accessed, a HOME button is shown which returns the view to the Home page seen in Figure 4-6 when pressed.

4.5.1.2. View Pages

4.5.1.2.1. Help File

A help file, accessible from each page via the help button  explains the full range of the utility's features. Refer to this file for a full explanation of each of the items visible in each page.

Figure 4-7 shows a portion of the help file.

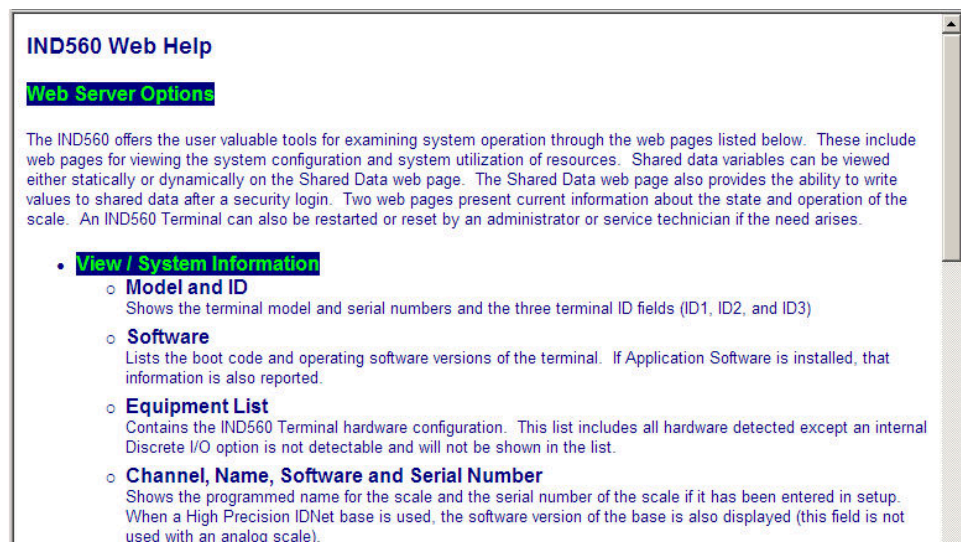

Figure 4-7: Help File

At the bottom of the Help page, a CLOSE WINDOW button allows the user to close this browser window without exiting the Web Server utility.

4.5.1.2.2. System Information

The system information page (Figure 4-8) provides information about asset information, installed component part numbers, software versions and serial numbers, and installed application software. The Channel Software column is not filled unless the terminal is using an IDNet or SICSprou scale base.

IND560 ?

View / System Information

Model: IND560
ID 1: IND560
ID 2: METTLER TOLEDO
ID 3:

Software

Boot: 2.01 14-Nov-08
Standard: 3.02 30-Mar-09
ACM boot: 1.01x08-Apr-09
ACM app: 1.01x26-Mar-09

Equipment List

Analog L/C
Option: Ethernet
Option: A-B RIO

Channel	Name	Software	Serial Number
1	Scale 1		Simulator

Home

Figure 4-8: System Information Page

4.5.1.2.3. Resource Utilization

The resource utilization page (Figure 4-9) gives a snapshot of the current status of the terminal, including power on time and information about the various types of memory used by the IND560x.

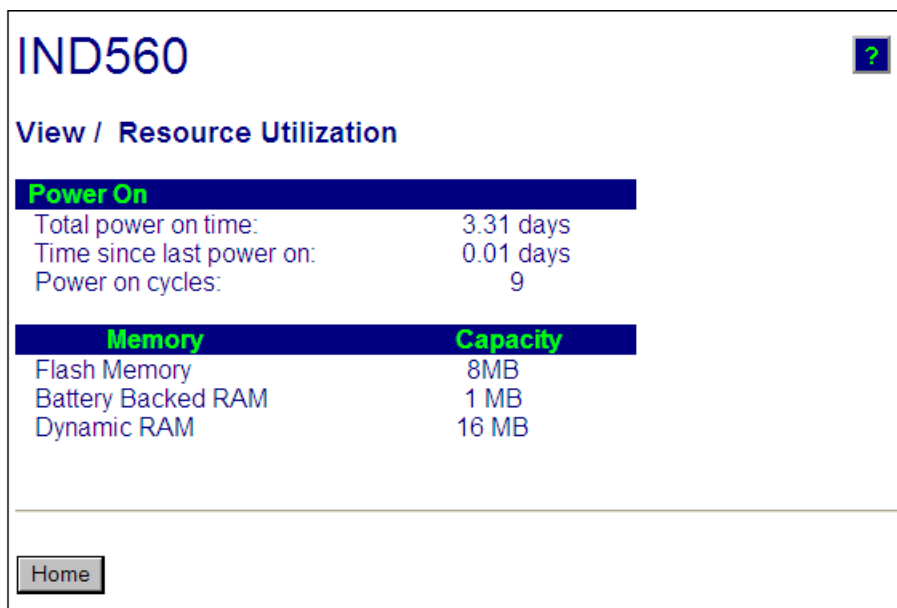

Figure 4-9: Resource Utilization Page

4.5.1.2.4. Scale Statistics

The scale statistics page (Figure 4-10) shows a variety of data for the scale.

IND560	
View / Scale Statistics	
Usage	
Usage Time	100.00%
Usage Cycles / Day	0
Transactions / Day	2
Total Transactions	19
Peak Loading	
Peak Weight	103.6 kg
Average Peak Load	27.8%
Total Weight	1107.9 kg
Statistics	
Scale Under Range	4
Scale Overloads	1
Zero Commands	5
Zero Command Failures	3
Zero Command Failures (%)	60%

Figure 4-10: Scale Statistics Page

4.5.1.2.5. Scale Data

The scale data page (Figure 4-11) shows information, including current configuration and calibration values, for the scale. The signal quality display permits troubleshooting of the connection between the IND560x and load cells. When quality is poor, a red bar is displayed. A yellow bar indicates adequate quality, and green bar means the quality is good, as in the example below.

The screenshot shows the 'IND560' scale data page. It features a title bar with 'IND560' and a help icon. Below the title is a 'View / Scale Data' section. The page is divided into three main sections: Capacity, Performance, and Calibration, each with a table of parameters and their values. The Signal Quality parameter in the Performance section is highlighted with a green bar, indicating good quality.

Capacity		Data
Scale Type		Analog
Number of Ranges		1
> 1 < Capacity		100
> 1 < Increment		0.01
> 1 < Display Increments		10000
> 2 < Capacity		
> 2 < Increment		
> 2 < Display Increments		
> 3 < Capacity		
> 3 < Increment		
> 3 < Display Increments		

Performance		Data
Counts / Display Increment		63.45
Signal Quality		Good (Green Bar)
Current Counts		114353
Last Zero Counts		101.84
Adjusted Counts		114251.16
Current Weight		18.01 kg

Calibration		Data
Calibration Zero Counts		120
Linearity Adjust		Disabled
Load 1 Test Weight		100 kg
Load 1 Span Counts		634622
Load 2 Test Weight		
Load 2 Span Counts		
Load 3 Test Weight		
Load 3 Span Counts		
Load 4 Test Weight		
Load 4 Span Counts		
Last Calibration Method		Test Weight
Geo Code		16
mV/V Jumper		3mV/V

Figure 4-11: Scale Data Page

4.5.1.3. Diagnostics & Maintenance Pages

4.5.1.3.1. Shared Data

The shared data page (Figure 4-12) allows the user to request a display of current values for up to ten shared data variables at a time. Values are accessed by entering the shared data name in one

of the fields at left. When the Save Changes button at bottom is clicked, the Name fields are saved and the Values refreshed. The button is in focus when a new entry has been made in a Name field.

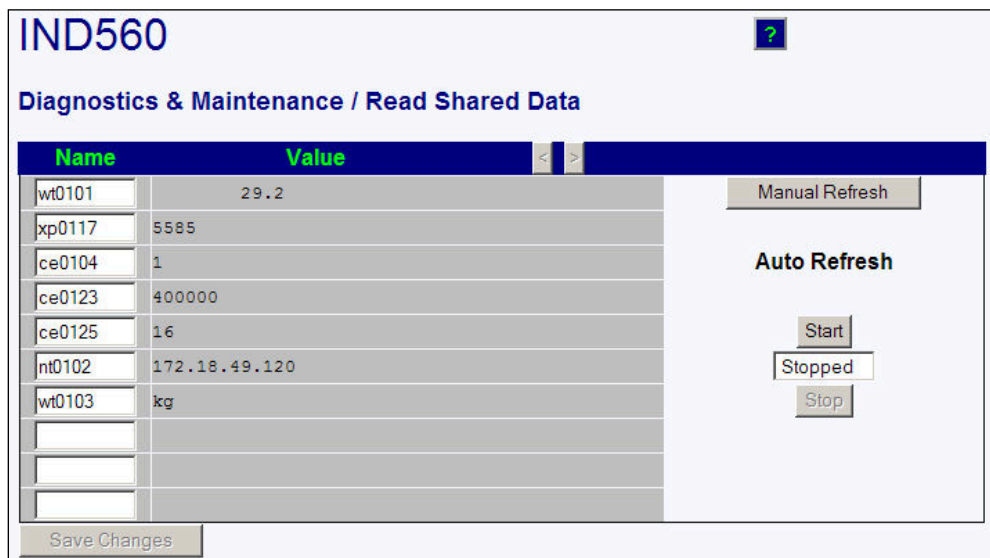

Figure 4-12: Shared Data Page

To refresh the displayed values without changing any variable names, click on the Manual Refresh button.

Values may also be refreshed automatically, at one second intervals, by clicking on the Start button. Once Start is selected, the Stop button is in focus and can be clicked. The current status of dynamic display (Stopped or Running) is shown in a field between the two buttons. Note that, as indicated on the page, Auto Refresh must be stopped before new shared data names can be entered.

For a complete list of available shared data names, refer to the IND560x Shared Data Manual. In the example shown in Figure 4-12, the shared data information displayed is as follows:

Table 4-4: Shared Data Information

Name	Data Displayed	Interpretation
wt0101	29.2	Current gross weight value
xp0117	5585	Cumulative power on time, in minutes
ce0104	1	Number of ranges defined for the scale
ce0123	400000	Encoder counts at the middle calibration value for the scale
ce0125	16	GEO code set in the Scale 2 calibration page
nt0102	172.18.49.120	Ethernet IP Address
wt0103	kg	Primary units set in the scale calibration page

When a string is longer than the data display width of 40 characters, the left/right scroll buttons  may be used to move through the string to view all of it.

4.5.1.3.2. Write Shared Data

To access the Write Shared Data page, login at the administrator level is required. When prompted, enter the administrator's user name and password. The screen shown in Figure 4-13 will appear.

Name	Value

Figure 4-13: Write Shared Data Page

Enter the Shared Data name in the Name column at left, and the value to be written to it in the Value column, then click on the Write button. Four Shared Data variables can be modified at a time.

4.5.1.3.3. Reset Terminal

To access the Reset Terminal page, login at the administrator level is required. When prompted, enter the administrator's user name and password. The screen shown in Figure 4-14 will appear.

Figure 4-14: Reset Terminal Page

From this screen, the terminal can be restarted (equivalent to cycling power) or reset to factory defaults (except for calibration settings, tables and log files), with results as detailed on-screen.

- When a Master Reset is performed, the Terminal's IP address will default to factory settings.

METTLER TOLEDO Service

To protect your METTLER TOLEDO product's future:

Congratulations on choosing the quality and precision of METTLER TOLEDO. Proper use according to these instructions and regular calibration and maintenance by our factory-trained service team ensure dependable and accurate operation, protecting your investment. Contact us about a METTLER TOLEDO service agreement tailored to your needs and budget.

We invite you to register your product at www.mt.com/productregistration so we can contact you about enhancements, updates and important notifications concerning your product.

www.mt.com/IND560

For more information

Mettler-Toledo, LLC

1900 Polaris Parkway
Columbus, OH 43240
Phone 800 438 4511
Fax 614 438 4900

© 2021 Mettler-Toledo, LLC
64062161 Rev. 13, 08/2022



64062161